

SUBMERSIBLE PUMPS

AFP 0831 to 2046

CE

DIN/EN 12050-1

Robust, reliable sewage pumps from 1.3 to 22 kW for pumping wastewater and sewage from buildings and sites in private, commercial, industrial and communal areas. Available with ContraBlock® or Vortex impellers

Applications

ABS centrifugal pumps of the AFP series have been designed for economical and reliable pumping of sewage from private, commercial, communal and industrial sources.

They are suitable for clear and wastewater, and for sewage and sludge containing solid and fibrous material as well as for gaseous liquids. Used in conjunction with the ABS automatic coupling system the below ground level wet installation is a particularly economical solution. It avoids the necessity to enter sump to remove pump. The pumps are also suitable for portable applications as well as for horizontal or vertical dry installation. These pumps are available both in standard and in explosion-proof versions in accordance with international standards e.g. EExd II BT4 and FM.

Maximum ambient temperature +40° C, information on applications at other temperatures available on request.

Construction

The water-tight fully flood-proof motor and pump section form a compact and robust unit.

Motor

Three-phase squirrel-cage motor 400 V3-, 50 Hz, 2-pole (2900 min⁻¹), 4-pole (1450 min⁻¹) and 6-pole (980 min⁻¹), protection type IP 68, stator insulation class F, for 155° C, direct starting up to 3 kW, from 4 kW is star-delta or direct starting possible. Motors with other operating voltages and frequencies are available.

Rotor shaft

is supported in lubricated for life maintenance-free ball-bearings.

Shaft sealing

between motor and hydraulic section by means of high quality sealing unit using a silicon carbide mechanical seal, independent of direction of rotation and resistant to temperature shock.

Seal monitoring: DI-System*

DI-system with a sensor in the oil chamber and motor chamber to give a timely indication that an inspection is due and leakage at the shaft seal has occurred.

Temperature monitoring*

TCS-Thermo-Control-System with thermal sensors in the stator to give a warning and switch off the pump should overheating of the motor occur and switches on automatically after cooling down.

Motor cooling

As standard supplied without cooling jacket for free circulation cooling. Optional with open jacket cooling system (M-motors only), Closed cooling system on 'ME' models.

Hydraulics

ContraBlock® System

consisting of spiral bottom plate with waved shearing cutting edge, and open ABS channel type impeller, prevents blockage of the impeller where large quantities of solid or fibrous matters are present.

Vortex impeller

Vortex impeller for pumping of materials which tend to "rope".

Discharge outlet

Discharge outlet with DIN-flange: DN 80, 100, 150 and 200.

* Standard on M-motors, optional on S-motors



- For wastewater and for sewage and sludge containing solid or fibrous particles and storm water
- Hydraulic design with ContraBlock® System or Vortex impellers
- Jacket cooling system as an option
- Automatic seal and temperature monitoring at all times
- High operational reliability even under continuous operating conditions
- Available in transportable execution
- High performance and output
- In standard or Ex-versions

Materials

Motor housing _____ Cast Iron GG-25
 Rotor shaft _____ Stainless steel 1.4021 (AISI 420)
 Volute _____ Cast Iron GG-25
 Impeller CB _____ Cast Iron GG-25
 Impeller Vortex _____ Cast Iron GG-25
 Fasteners in contact with medium _ Stainless steel 1.4401 (AISI 316)

Options

Rotor shafts _____ Stainless steel 1.4401 (AISI 316)
 Impellers _____ Stainless steel 1.4460 (AISI 329)

Certain models (classified as SX) are also available entirely in stainless steel for chemical and corrosive applications. Surface hardened impeller and bottom plate versions available for special applications-contact ABS for details

SUBMERSIBLE PUMPS AFP 0831 to 2046

Technical Data

Pump type		Motor power*		Speed at 50 Hz	Rated voltage	Rated current at 400 V	Starting	Cable type**		Weight without/with cooling jacket kg	
Hydraulics	Motor	Impeller size	P ₁ kW	P ₂ kW	min ⁻¹	V 3 ~	A	400 V	220-240~ V		
AFP 0831	M 15/4	(3)	2.5	1.95	1450	400	4.65	dir.	(1)	(1)	78 / 90
0831	M 22/4	(2)	2.88	2.2	1450	400	5.15	dir.	(1)	(1)	78 / 90
0831	M 30/4	(1)	3.95	3.0	1450	400	7.0	dir.	(1)	(1)	80 / 92
0831	S 22/4	(2)(3)	2.9	2.2	1450	400	5.2	dir.	(5)	(5)	45 / n.a.
0831	M 13/6	(1)(2)(3)	1.81	1.3	980	400	3.7	dir.	(1)	(1)	76 / 88
AFP 0832	M 70/2	(1)(2)(3)	8.37	7.0	2900	400	13.6	YΔ	(2)	(2)	105 / 121
0832	M 40/2	(4)	4.86	4.0	2900	400	7.9	YΔ	(2)	(2)	81 / 93
AFP 0834	M 110/2	(1)(2)(3)(4)	13.3	11.0	2900	400	22.1	YΔ	(2)	(3)	95 / 103
AFP 0841	M 15/4	(1)(2)(3)(4)	2.5	1.95	1450	400	4.65	dir.	(1)	(1)	78 / 90
0841	M 30/4	(A)	3.95	3.0	1450	400	7.0	dir.	(1)	(1)	80 / 92
0841	S 22/4	(1)	2.9	2.2	1450	400	5.2	dir.	(5)	(5)	56 / n.a.
0841	S 13/4	(2)(3)(4)	1.9	1.3	1450	400	3.6	dir.	(5)	(5)	41 / n.a.
0841	M 13/6	(1)(2)(3)(4)	1.81	1.3	980	400	3.7	dir.	(1)	(1)	76 / 88
AFP 0842	M 40/2	(1)	4.86	4.0	2900	400	7.9	YΔ	(2)	(2)	81 / 93
AFP 0844	M 110/2	(1)	13.3	11.0	2900	400	22.1	YΔ	(2)	(3)	110 / 120
0844	M 70/2	(2)	8.37	7.0	2900	400	13.6	YΔ	(2)	(2)	100 / 110
AFP 1031	M 30/4	(1)	3.95	3.0	1450	400	7.0	dir.	(1)	(1)	80 / 92
1031	M 22/4	(2)	2.88	2.2	1450	400	5.15	dir.	(1)	(1)	78 / 90
1031	M 15/4	(3)	2.5	1.95	1450	400	4.65	dir.	(1)	(1)	78 / 90
1031	M 13/6	(1)(2)(3)	1.81	1.3	980	400	3.7	dir.	(1)	(1)	76 / 88
AFP 1032	M 90/4	(A)	10.8	9.0	1450	400	19.4	YΔ	(2)	(3)	120 / 136
1032	M 60/4	(1)	7.22	6.0	1450	400	12.5	YΔ	(2)	(2)	110 / 126
1032	M 40/4	(2)	5.0	4.0	1450	400	8.9	YΔ	(2)	(2)	107 / 123
1032	M 30/6	(1)(2)	4.08	3.0	980	400	7.8	YΔ	(2)	(2)	107 / 123
AFP 1033	ME 185/4	(1)	20.6	18.5	1450	400	34.3	YΔ	(3)	(4)	290 / 320
1033	ME 160/4	(2)(3)	17.9	16.0	1450	400	30.4	YΔ	(3)	(4)	285 / 315
1033	ME 110/4	(4)	12.4	11.0	1450	400	23.2	YΔ	(2)	(4)	280 / 310
1033	ME 90/6	(1)(2)(3)(4)	10.1	9.0	980	400	20.4	YΔ	(3)	(4)	285 / 315
AFP 1034	ME 200/2	(1)(2)(3)(4)(5)(6)	22.1	20.0	2900	400	37.0	YΔ	(3)	(4)	230 / 260
1034	ME 185/2	(7)	20.4	18.5	2900	400	34.4	YΔ	(3)	(4)	225 / 255
1034	ME 150/2	(8)	16.5	15.0	2900	400	28.7	YΔ	(3)	(4)	220 / 250
AFP 1041	M 30/4	(1)(2)	3.95	3.0	1450	400	7.0	dir.	(1)	(1)	80 / 92
1041	M 22/4	(3)	2.88	2.2	1450	400	5.15	dir.	(1)	(1)	78 / 90
1041	M 15/4	(4)	2.5	1.95	1450	400	4.65	dir.	(1)	(1)	78 / 90
1041	M 13/6	(1)(2)(3)(4)	1.81	1.3	980	400	3.7	dir.	(1)	(1)	76 / 88
AFP 1042	M 90/4	(A)	10.8	9.0	1450	400	19.4	YΔ	(2)	(3)	117 / 133
1042	M 60/4	(1)(2)	7.22	6.0	1450	400	12.5	YΔ	(2)	(2)	110 / 126
1042	M 40/4	(3)	5.0	4.0	1450	400	8.9	YΔ	(2)	(2)	107 / 123
1042	M 30/6	(A)(1)(2)(3)	4.08	3.0	980	400	7.8	YΔ	(2)	(2)	107 / 123
AFP 1043	M 70/2	(1)	8.37	7.0	2900	400	13.6	YΔ	(2)	(2)	105 / 121
AFP 1045	ME 220/4	(A)	24.3	22.0	1450	400	42.3	YΔ	(3)	(4)	300 / 320
1045	ME 185/4	(1)	20.6	18.5	1450	400	34.3	YΔ	(3)	(4)	290 / 320
1045	ME 160/4	(2)	17.9	16.0	1450	400	30.4	YΔ	(3)	(4)	285 / 315
1045	ME 140/4	(2B)	15.7	14.0	1450	400	27.3	YΔ	(3)	(4)	285 / 315
1045	ME 110/4	(3)	12.4	11.0	1450	400	23.2	YΔ	(2)	(4)	280 / 315
1045	ME 90/6	(1)(2)(2B)(3)	10.1	9.0	980	400	20.4	YΔ	(3)	(4)	285 / 315
AFP 1048	ME 200/2	(1)	22.1	20.0	2900	400	37.0	YΔ	(3)	(4)	250 / 275
1048	ME 185/2	(2)	20.4	18.5	2900	400	34.4	YΔ	(3)	(4)	245 / 270
1048	ME 150/2	(3)	16.5	15.0	2900	400	28.7	YΔ	(3)	(4)	240 / 265
AFP 1049	M 90/4	(A)(2)	10.8	9.0	1450	400	19.4	YΔ	(2)	(3)	129 / 145
1049	M 60/4	(3)	7.22	6.0	1450	400	12.5	YΔ	(2)	(2)	119 / 135
1049	M 40/4	(4)	5.0	4.0	1450	400	8.9	YΔ	(2)	(2)	111 / 127
1049	M 30/6	(A)(2)(3)(4)	4.08	3.0	980	400	7.8	YΔ	(2)	(2)	117 / 139
AFP 1533	ME 185/4	(1)	20.6	18.5	1450	400	34.3	YΔ	(3)	(4)	295 / 325
1533	ME 160/4	(2)(3)	17.9	16.0	1450	400	30.4	YΔ	(3)	(4)	290 / 320
1533	ME 110/4	(4)	12.4	11.0	1450	400	23.2	YΔ	(2)	(4)	285 / 315
1533	ME 90/6	(1)(2)(3)(4)	10.1	9.0	980	400	20.4	YΔ	(3)	(4)	290 / 320
AFP 1541	M 90/4	(A)	10.8	9.0	1450	400	19.4	YΔ	(2)	(3)	122 / 133
1541	M 60/4	(1)(2)	7.22	6.0	1450	400	12.5	YΔ	(2)	(2)	110 / 126
1541	M 40/4	(3)	5.0	4.0	1450	400	8.9	YΔ	(2)	(2)	107 / 123
1541	M 30/6	(A)(1)(2)(3)	4.08	3.0	980	400	7.8	YΔ	(2)	(2)	107 / 123
AFP 1543	ME 220/4	(A)	24.3	22.0	1450	400	42.3	YΔ	(3)	(4)	300 / 330
1543	ME 185/4	(1)	20.6	18.5	1450	400	34.3	YΔ	(3)	(4)	295 / 325
1543	ME 160/4	(2)	17.9	16.0	1450	400	30.4	YΔ	(3)	(4)	290 / 320
1543	ME 140/4	(2B)	15.7	14.0	1450	400	27.3	YΔ	(3)	(4)	290 / 320
1543	ME 110/4	(3)	12.4	11.0	1450	400	23.2	YΔ	(2)	(4)	285 / 315
1543	ME 90/6	(1)(2)(2B)(3)	10.1	9.0	980	400	20.4	YΔ	(3)	(4)	290 / 320

Technical Data

Pump type		Impeller size	Motor power*		Speed at 50 Hz min ⁻¹	Rated voltage V 3 ~	Rated current at 400 V A	Starting	Cable type**		Weight without/with kg
Hydraulics	Motor		P ₁ kW	P ₂ kW					400 V	cooling jacket 220-240~ V	
AFP 1546	M 90/4	(A)	10.8	9.0	1450	400	19.4	YΔ	(2)	(3)	122 / 133
	M 60/4	(2)	7.22	6.0	1450	400	12.5	YΔ	(2)	(2)	110 / 126
	M 40/4	(4)	5.0	4.0	1450	400	8.9	YΔ	(2)	(2)	107 / 123
	M 30/6	(A)(2)(4)	4.08	3.0	980	400	7.8	YΔ	(2)	(2)	107 / 123
AFP 2045	ME 220/4	(1)	24.3	22.0	1450	400	42.3	YΔ	(3)	(4)	330 / 360
	ME 185/4	(1)	20.6	18.5	1450	400	34.3	YΔ	(3)	(4)	330 / 360
	ME 160/4	(2)(3)	17.9	16.0	1450	400	30.4	YΔ	(3)	(4)	325 / 355
	ME 110/4	(4)	12.4	11.0	1450	400	23.2	YΔ	(2)	(4)	320 / 350
	ME 90/6	(1)(2)(3)(4)	10.1	9.0	980	400	20.4	YΔ	(3)	(4)	325 / 355
AFP 2046	ME 140/6	(1)	16.1	14.0	980	400	28.1	YΔ	(3)	(4)	330 / 360
	ME 110/6	(2)	12.5	11.0	980	400	23.2	YΔ	(3)	(4)	325 / 355
	ME 90/6	(4)(5)	10.1	9.0	980	400	20.4	YΔ	(3)	(4)	325 / 355

P₁ = Power taken from mains; P₂ = Power at motor shaft
Standard execution is with 10 m cable and free cable ends.

**Cable type: (1) Special rubber 7G1.5 (3) Special rubber 10G2.5
(2) Special rubber 10G1.5 (4) Special rubber 4G4 + 2 x 0.75
(5) Special rubber 4G1.5 (7G1.5 for Ex or special versions)

Installation Options

There are four basic types of installation of the AFP Pumps:

Wet Installation

stationary

For stationary underfloor wet installation in collection sump with ABS coupling pedestal and single guide tube.

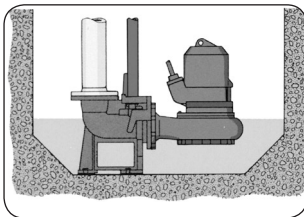

Accessories

- ABS Coupling Pedestal with bracket
- Guide tube with pipe retainer
- Chain with shackle
- Check valve
- Gate valve

Wet Installation

transportable

For speedy applications in emergency situations or for service applications.

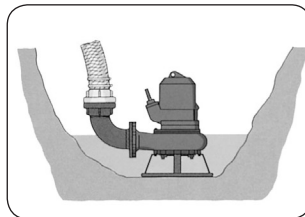

Accessories

- Discharge elbow with flange
- Flanged sleeve
- Discharge hose with hose clips
- Skirt base
- Chain with shackle

Dry Installation

horizontal

For flood-proof installation in pump stations or fitted to a tank.

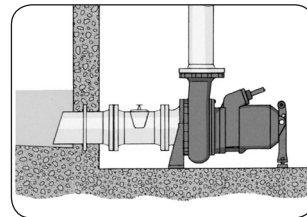

Accessories

- Volute support
- Head support with vibration damper
- Intermediate flanged piece with cleaning opening
- Check valve and gate valve

Dry Installation

vertical

For flood-proof fitting in pump stations with separate collection sump.

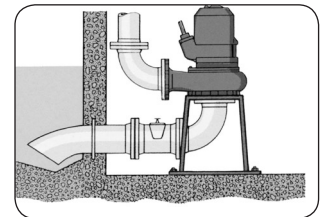

Accessories

- Ground support frame
- Suction bend with flanges
- Discharge elbow with flanges
- Check valve
- Gate valve

ABS Coupling System for Wet Installation

The fixed underfloor wet installation in a collection sump with the ABS coupling pedestal and single guide tube is a particularly economical solution which also helps to preserve the environment.

The ABS automatic coupling system ensures a quick and rational installation and operation of the pump. The ABS pedestal is fitted on the sump floor during erection of the pumping station, and connected to the discharge line. A guide tube connects the pedestal with the pipe retainer at the opening of the sump.

The ABS submersible pump is lowered along the guide tube, and reaches automatically its correct operating position. It seals automatically on the pedestal by its own weight.

A particularly advantageous feature of the ABS automatic coupling system is that it facilitates checking and inspection work. The pump is simply raised out of the sump with the chain (even when the unit is flooded), and lowered down again after maintenance work has been carried out.

SUBMERSIBLE PUMPS AFP 0831 to 2046

Performance Curves 50 Hz, DN 80

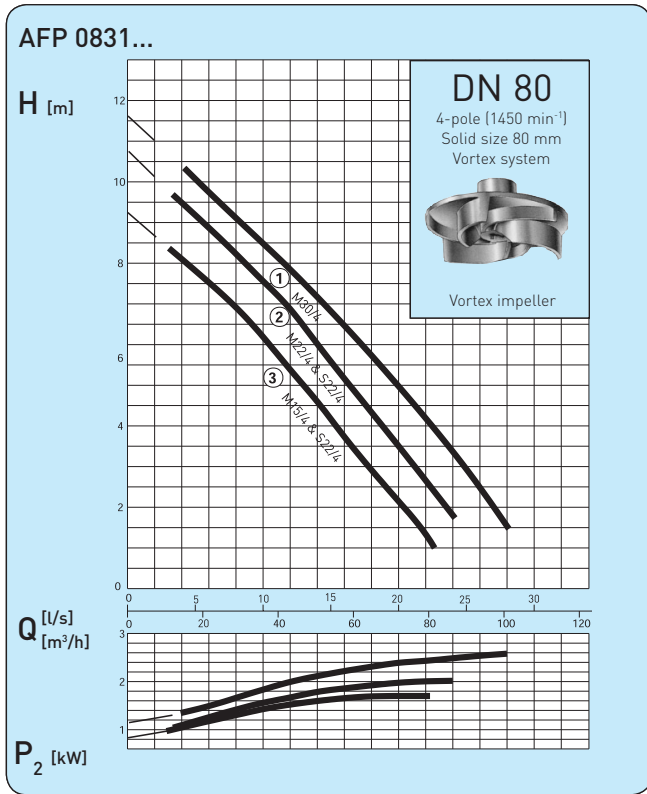

Performance Curves 50 Hz, DN 80

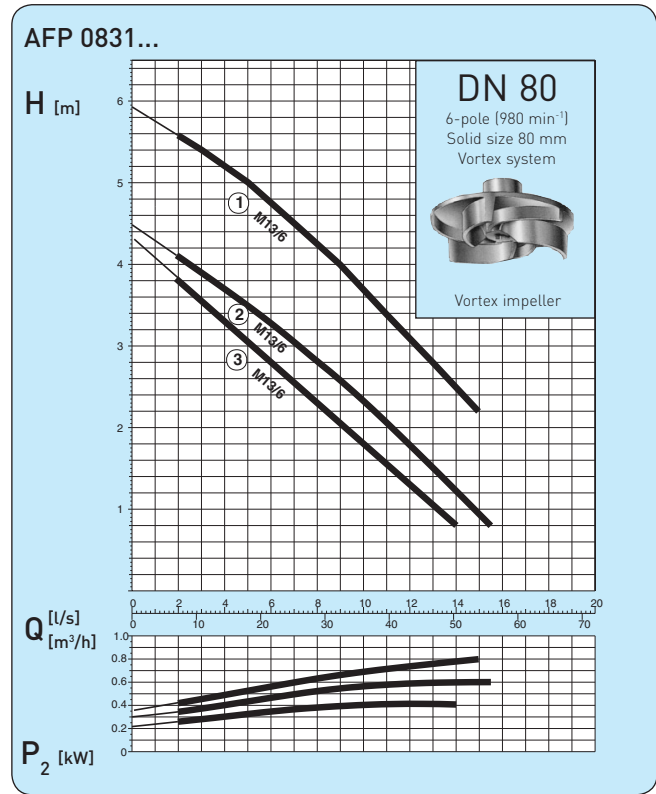

Performance Curves 50 Hz, DN 80

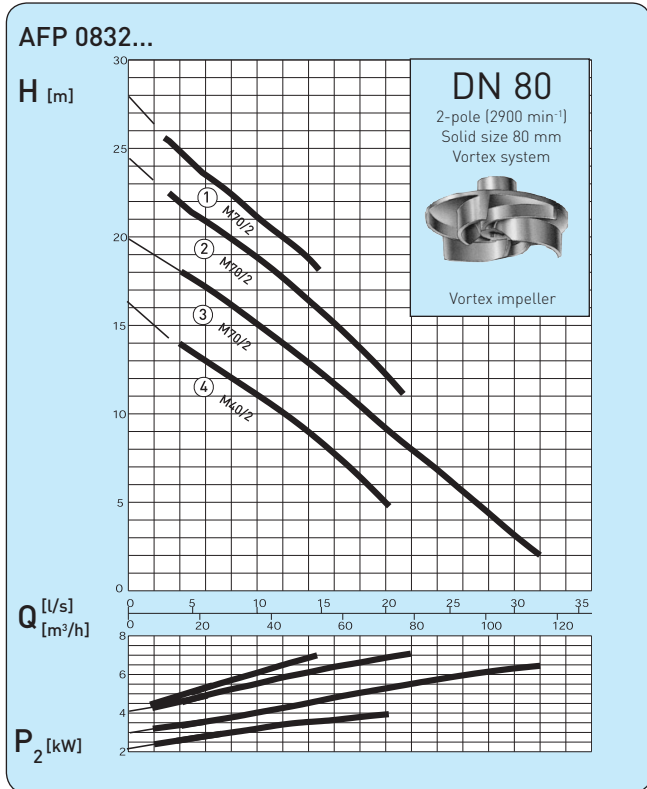

Performance Curves 50 Hz, DN 80

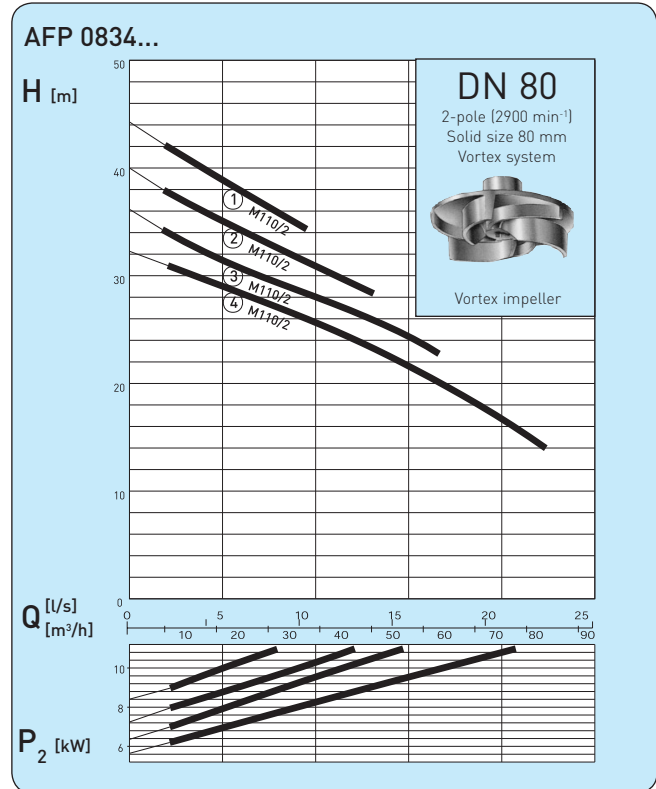

H = Total Head Q = Discharge Volume P₂ = Power at motor shaft

Curves to ISO 9906

Curves for 60 Hz are available on request.

Performance Curves 50 Hz, DN 80

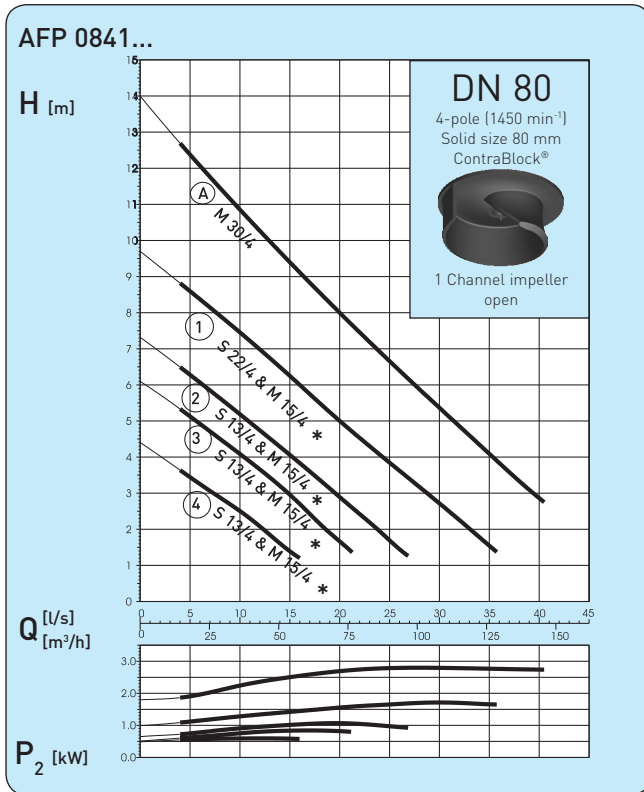

Performance Curves 50 Hz, DN 80

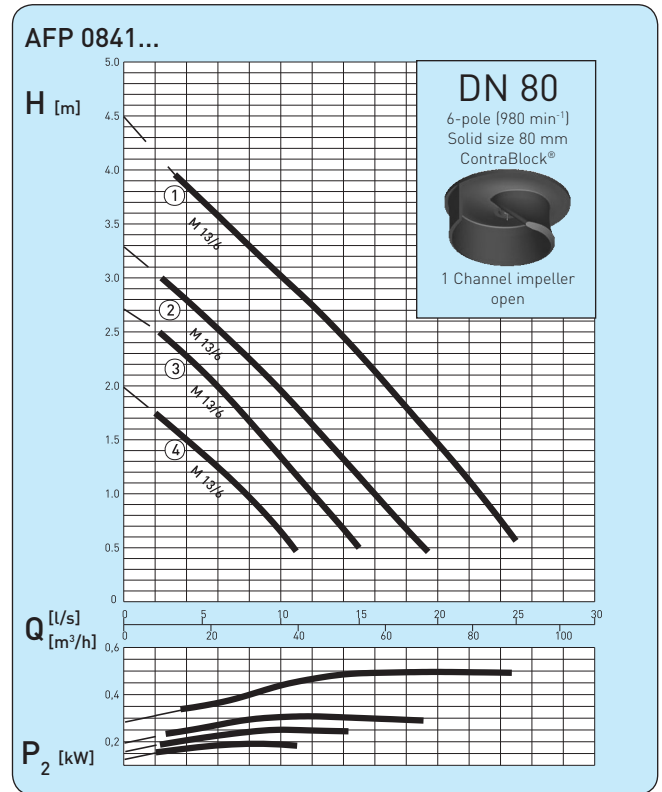

Performance Curves 50 Hz, DN 80

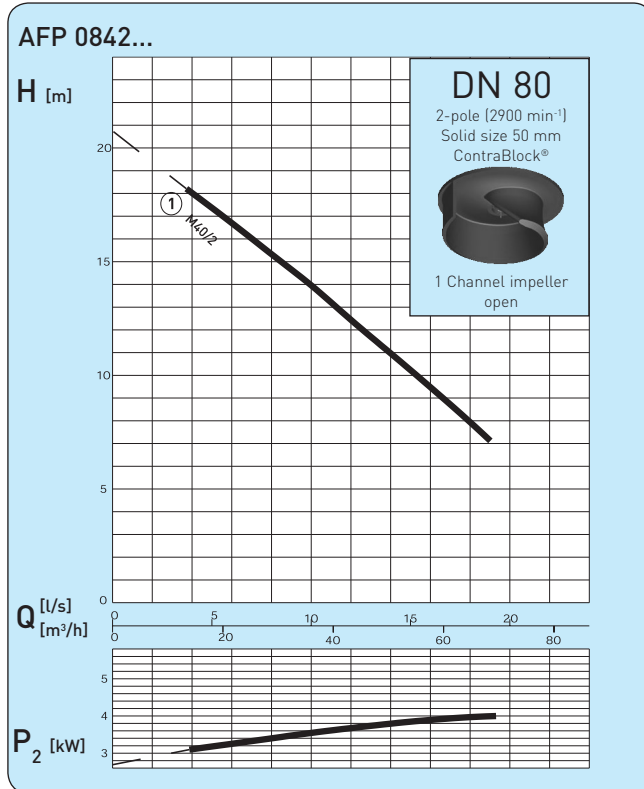

Performance Curves 50 Hz, DN 80

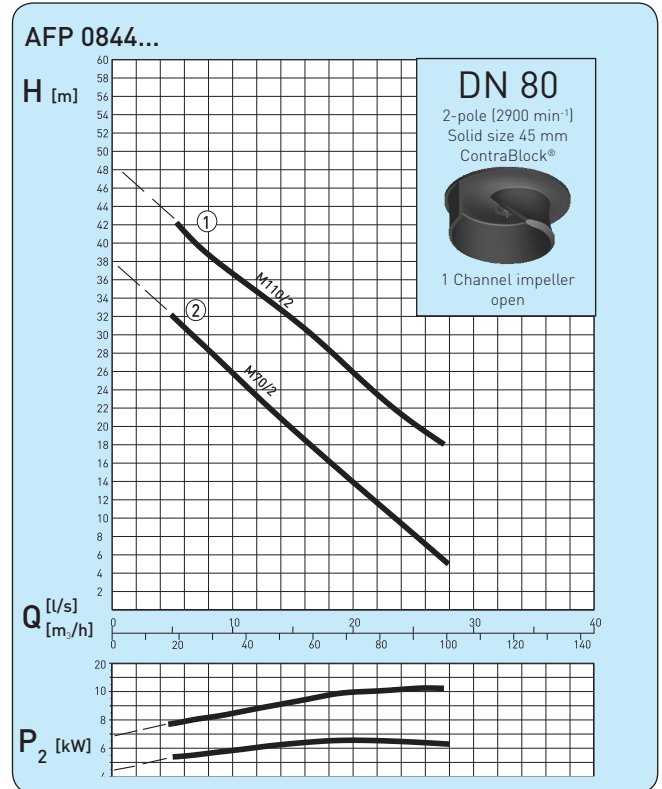

H = Total Head Q = Discharge Volume P₂ = Power at motor shaft

Curves to ISO 9906

Curves for 60 Hz are available on request.

* Only use M-motor when cooling jacket is needed,
S-Motor not available with cooling jacket

SUBMERSIBLE PUMPS AFP 0831 to 2046

Performance Curves 50 Hz, DN 100

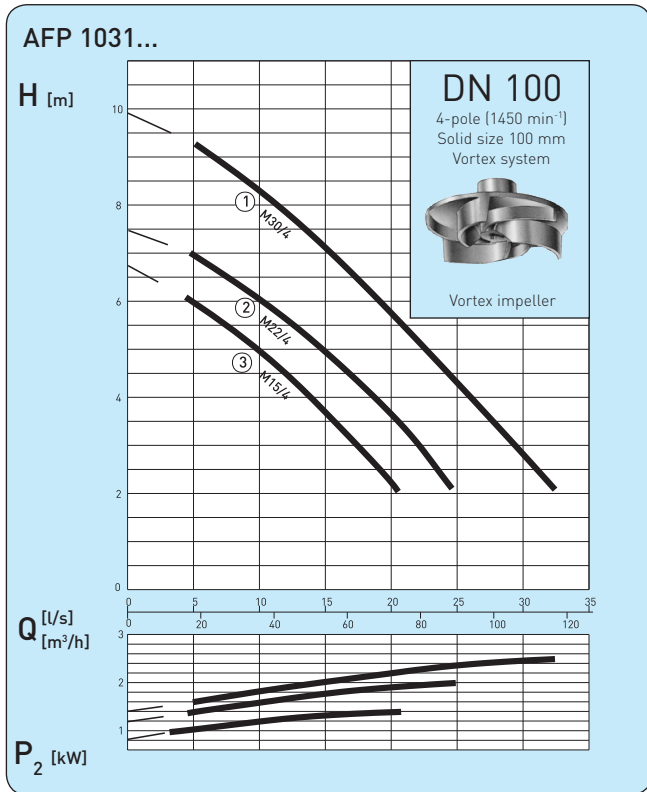

Performance Curves 50 Hz, DN 100

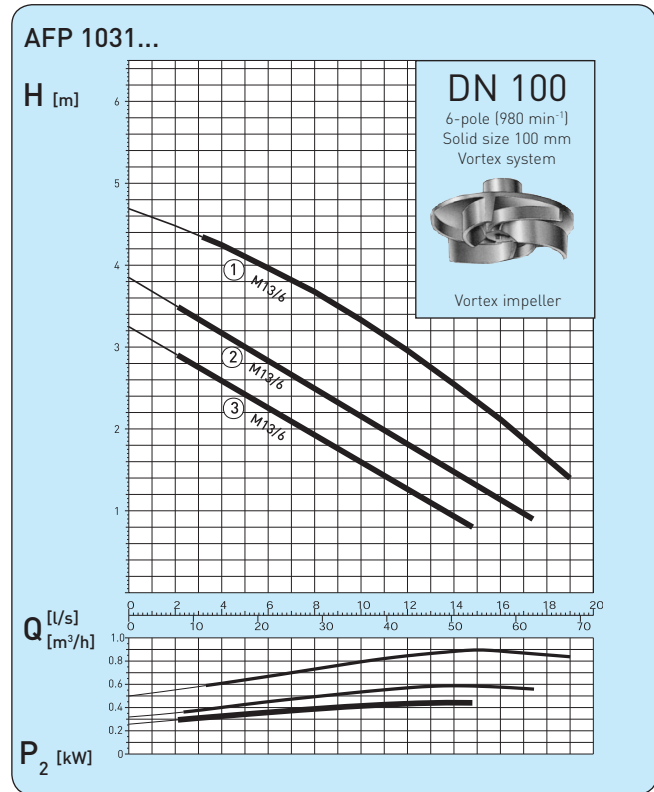

Performance Curves 50 Hz, DN 100

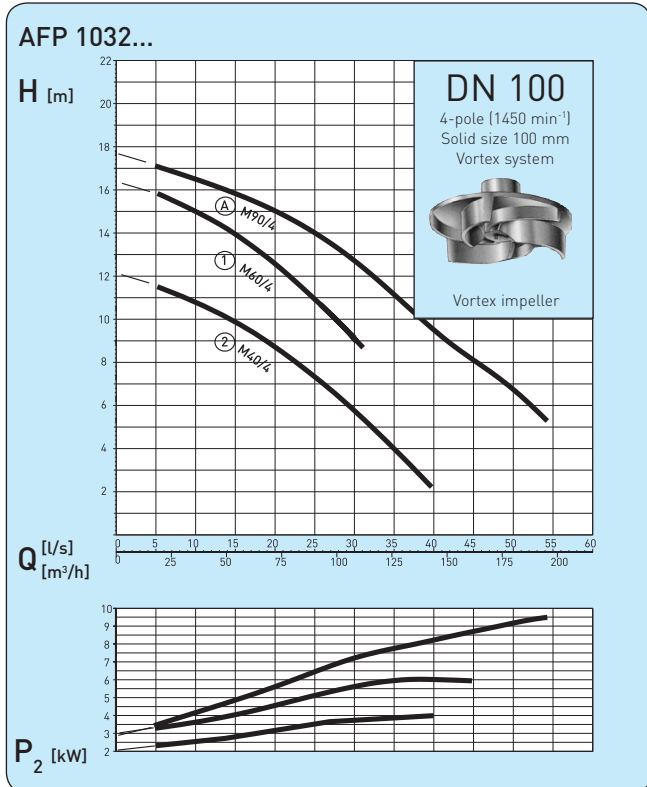

Performance Curves 50 Hz, DN 100

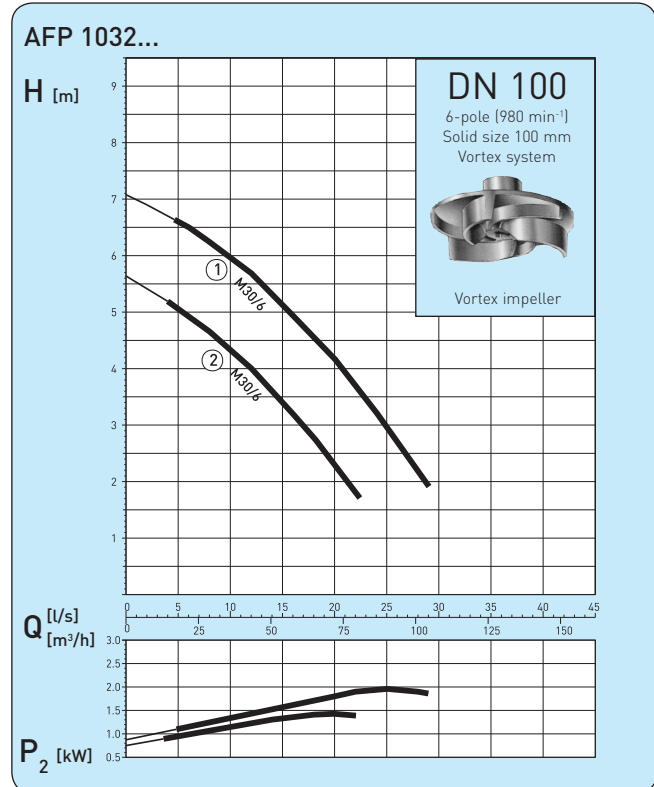

H = Total Head Q = Discharge Volume P₂ = Power at motor shaft

Curves to ISO 9906

Curves for 60 Hz are available on request.

Performance Curves 50 Hz, DN 100

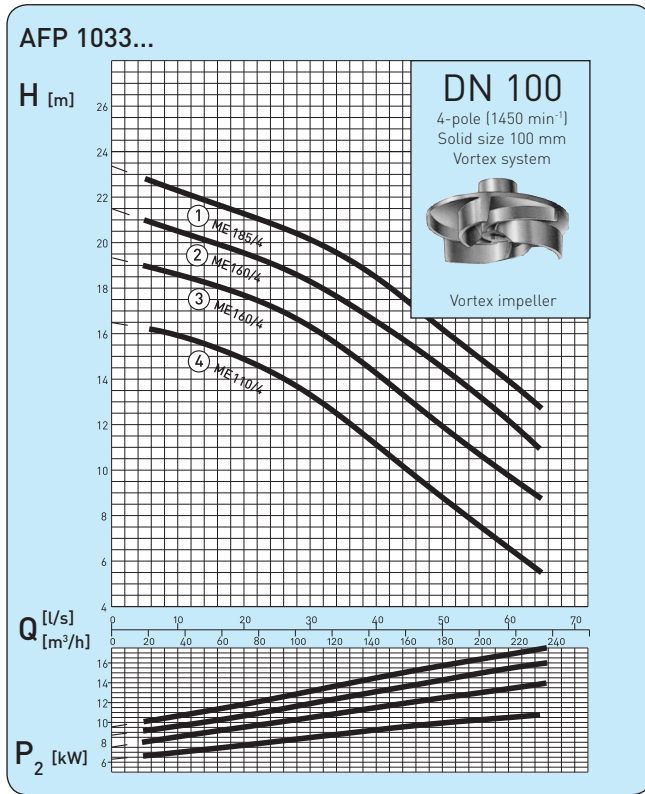

Performance Curves 50 Hz, DN 100

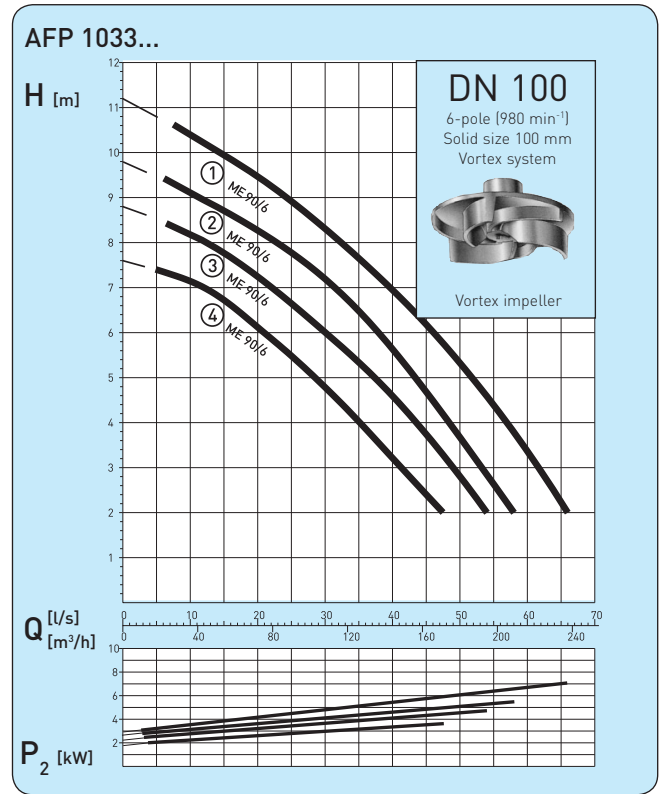

Performance Curves 50 Hz, DN 100

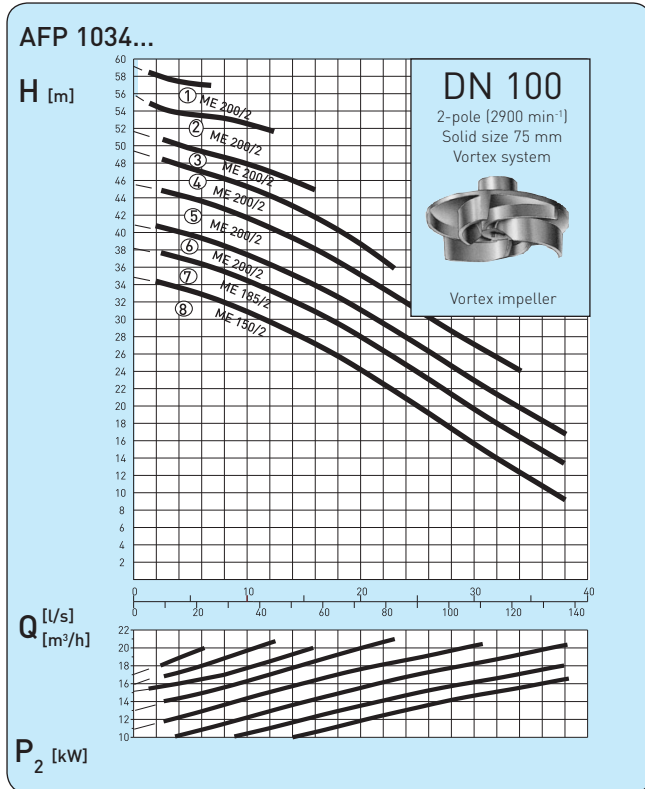

Performance Curves 50 Hz, DN 100

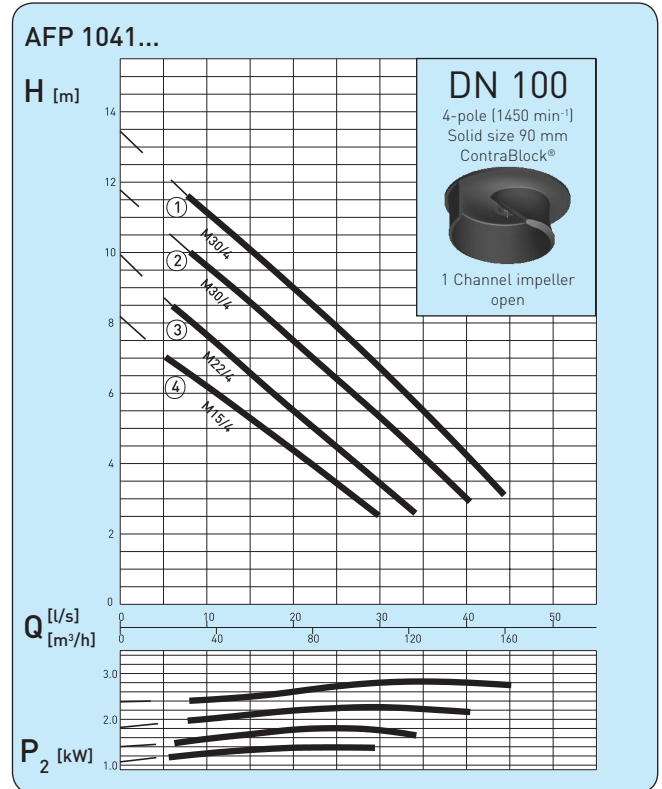

H = Total Head Q = Discharge Volume P₂ = Power at motor shaft

Curves to ISO 9906

Curves for 60 Hz are available on request.

SUBMERSIBLE PUMPS AFP 0831 to 2046

Performance Curves 50 Hz, DN 100

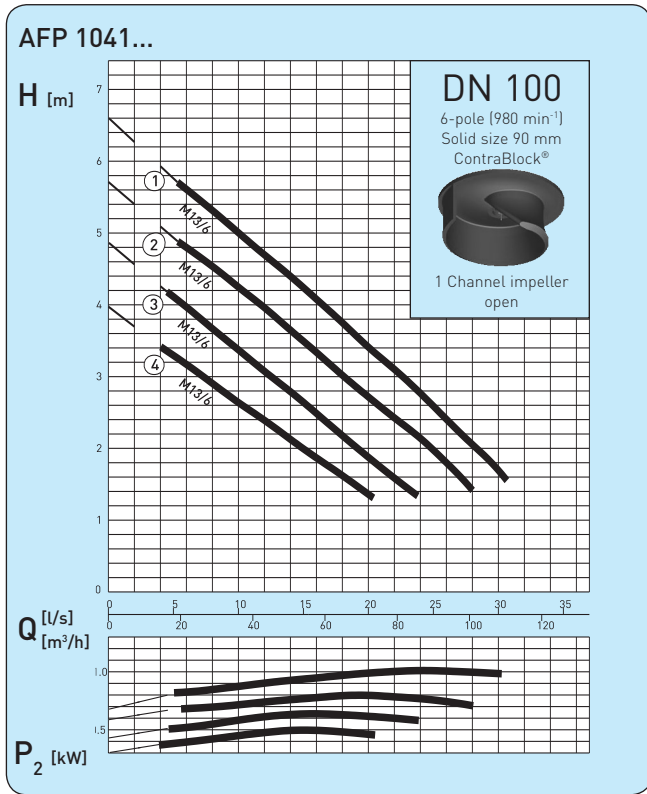

Performance Curves 50 Hz, DN 100

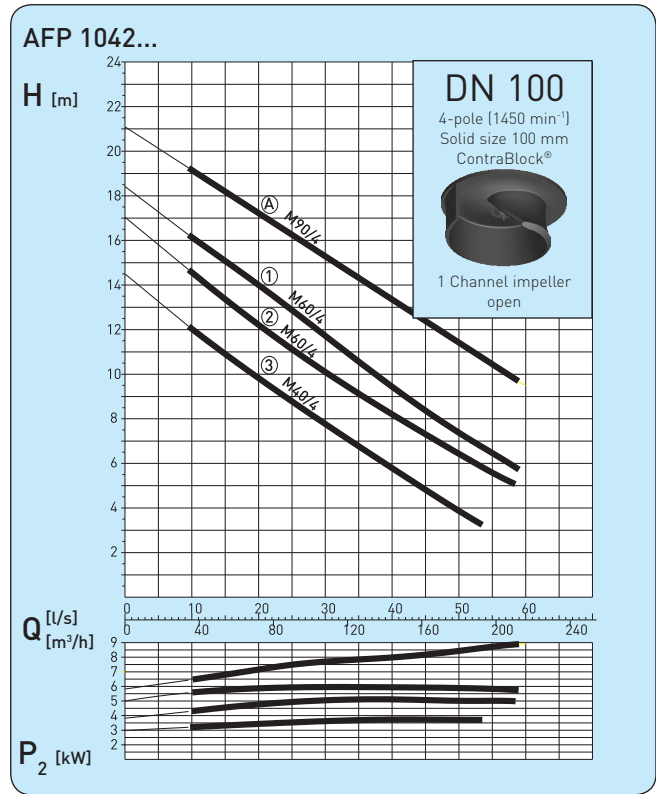

Performance Curves 50 Hz, DN 100

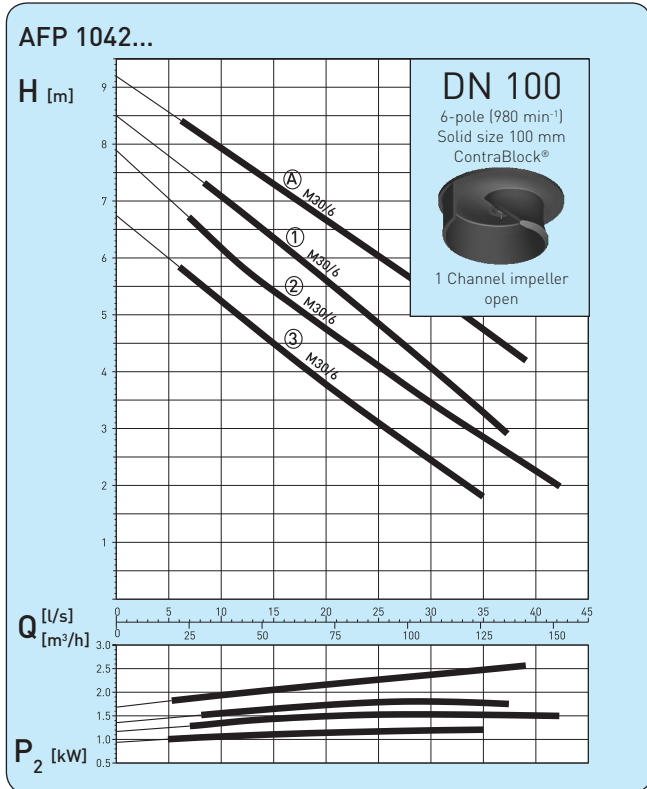

Performance Curves 50 Hz, DN 100

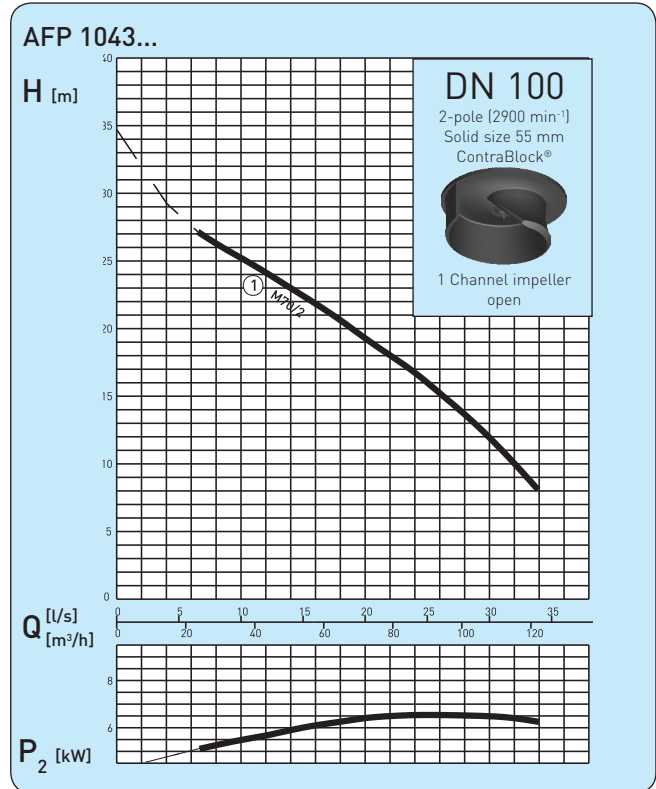

H = Total Head Q = Discharge Volume P₂ = Power at motor shaft

Curves to ISO 9906

Curves for 60 Hz are available on request.

Performance Curves 50 Hz, DN 100

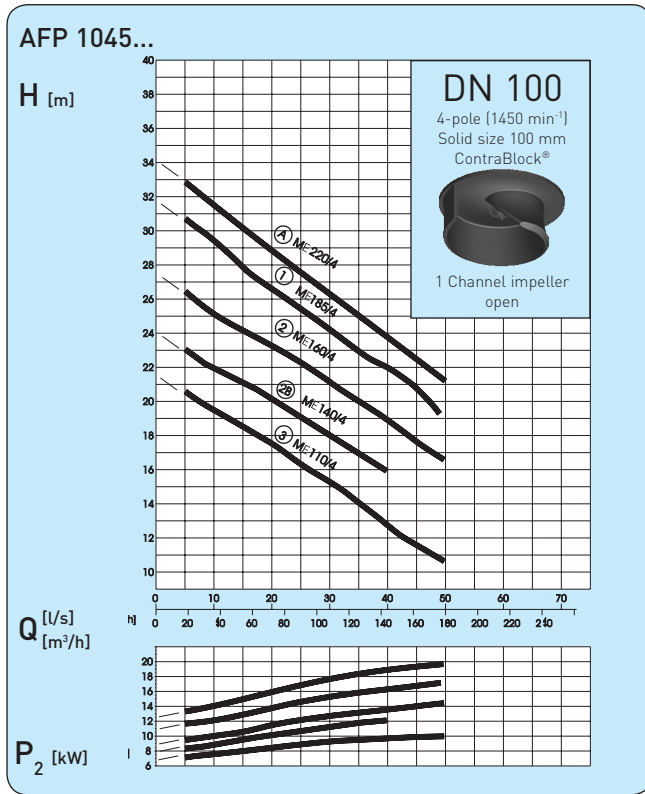

Performance Curves 50 Hz, DN 100

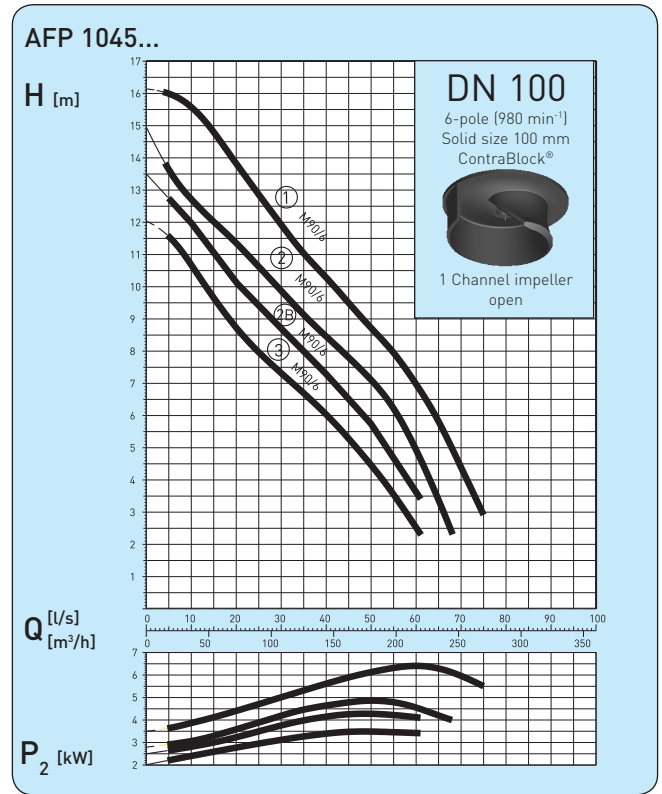

Performance Curves 50 Hz, DN 100

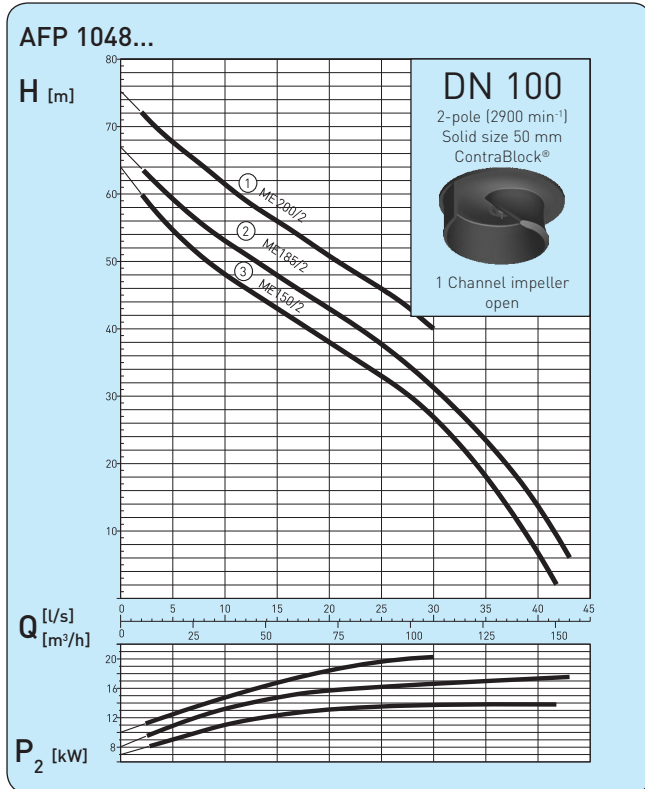

Performance Curves 50 Hz, DN 100

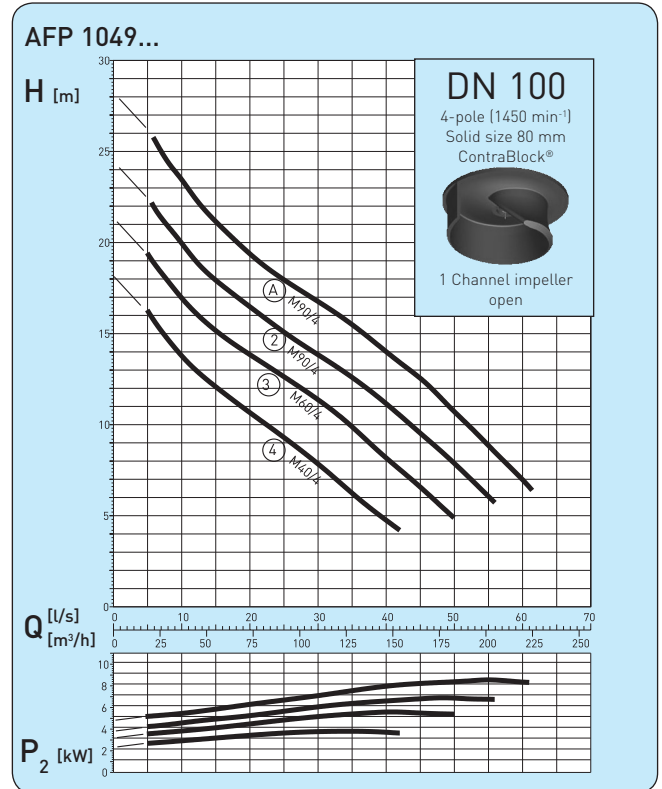

H = Total Head Q = Discharge Volume P₂ = Power at motor shaft

Curves to ISO 9906

Curves for 60 Hz are available on request.

SUBMERSIBLE PUMPS AFP 0831 to 2046

Performance Curves 50 Hz, DN 100

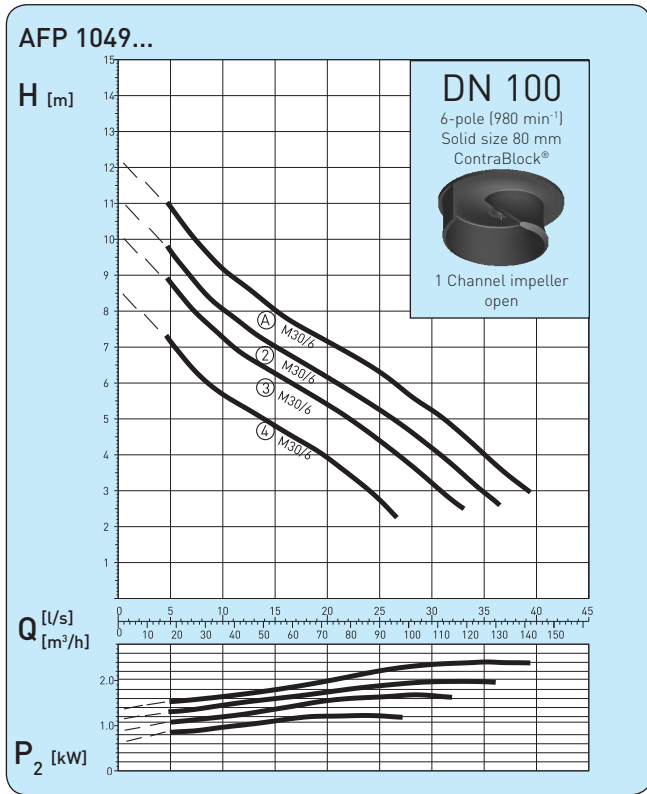

Performance Curves 50 Hz, DN 150

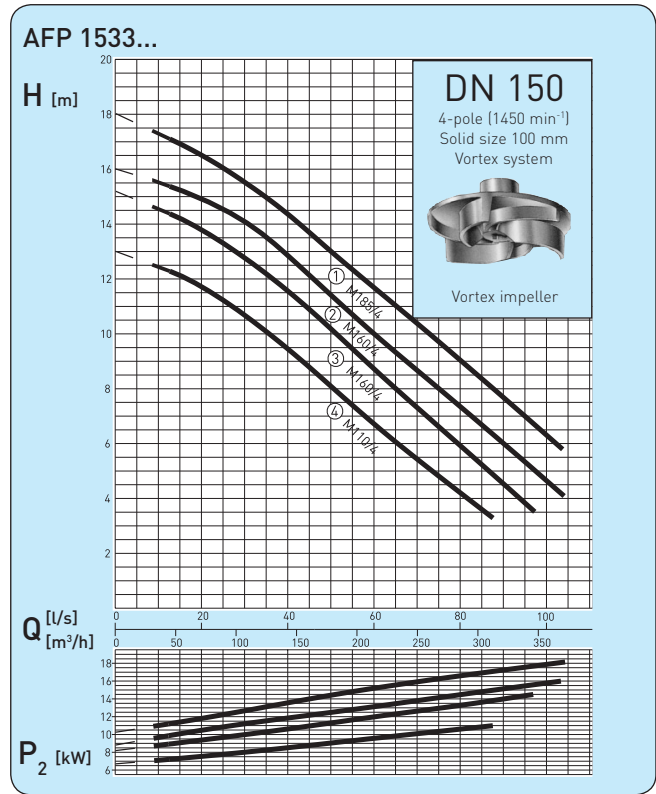

Performance Curves 50 Hz, DN 150

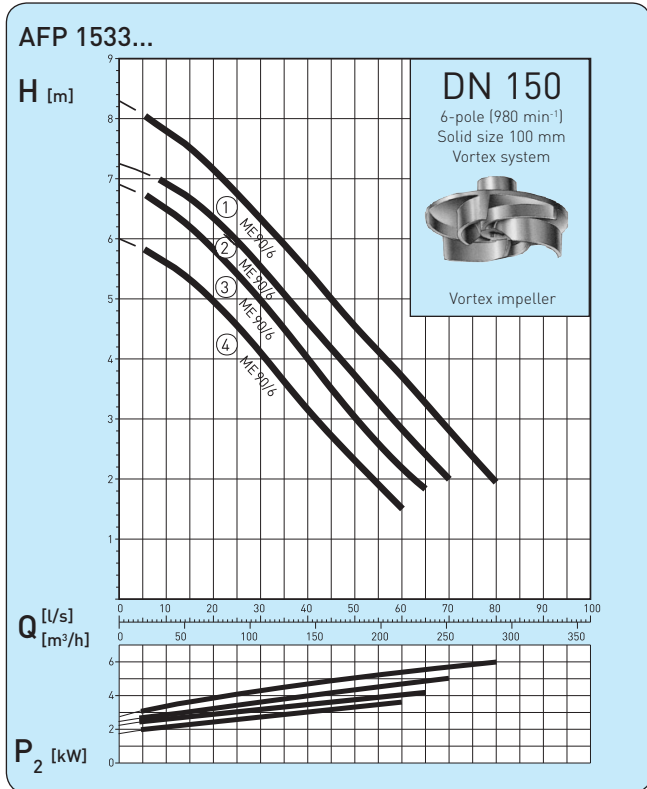

Performance Curves 50 Hz, DN 150

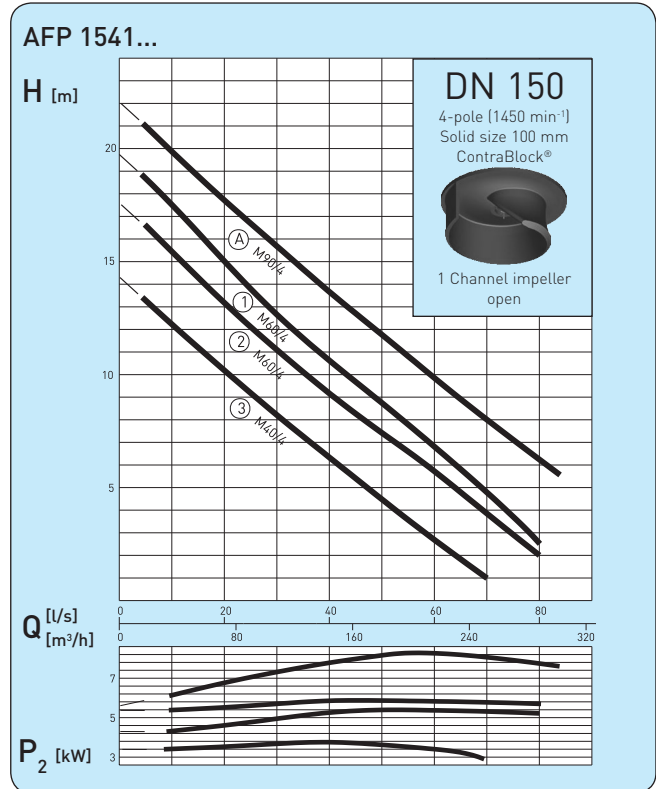

H = Total Head Q = Discharge Volume P₂ = Power at motor shaft

Curves to ISO 9906

Curves for 60 Hz are available on request.

Performance Curves 50 Hz, DN 150

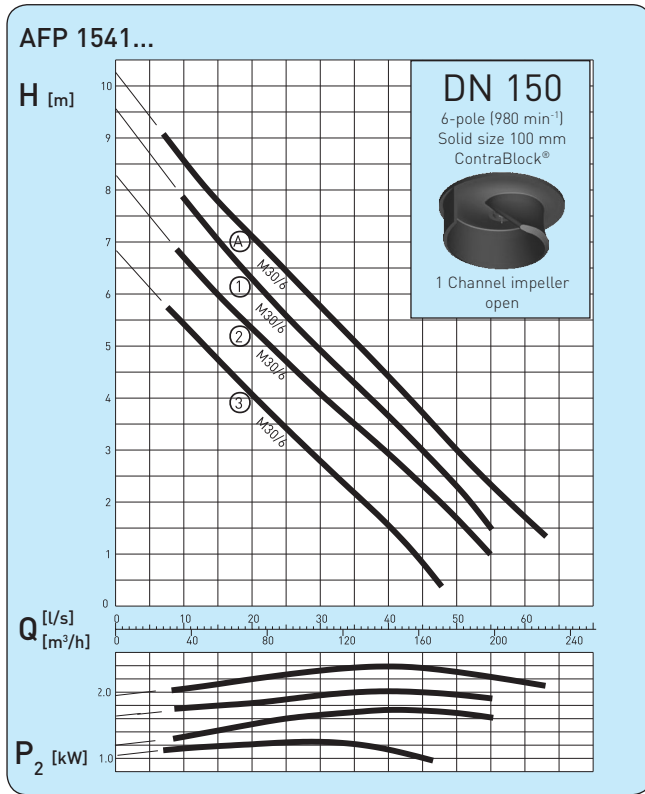

Performance Curves 50 Hz, DN 150

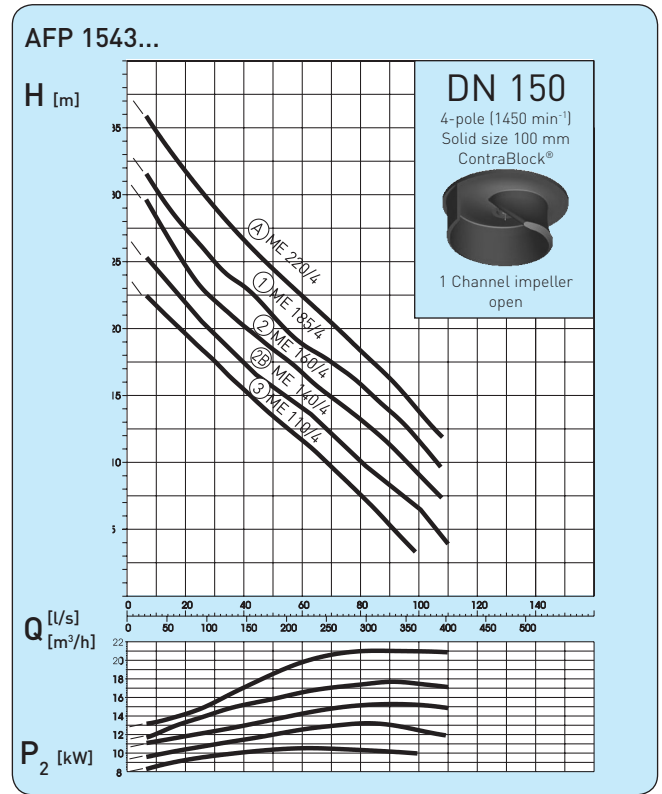

Performance Curves 50 Hz, DN 150

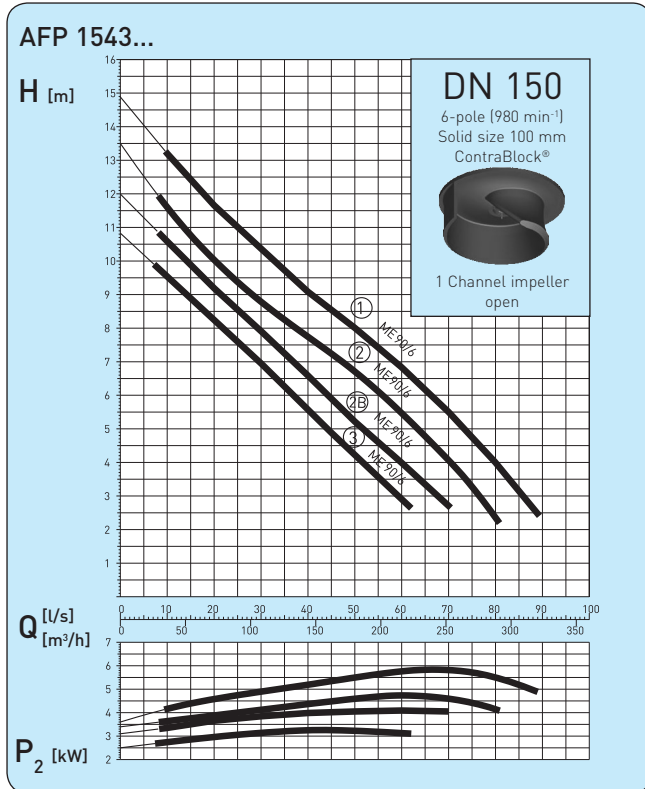

Performance Curves 50 Hz, DN 150

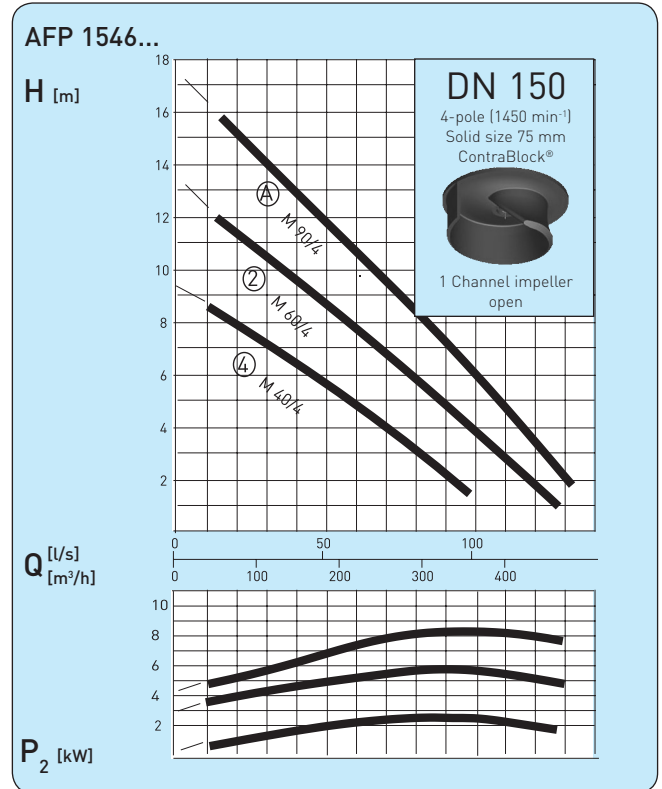

H = Total Head Q = Discharge Volume P₂ = Power at motor shaft

Curves to ISO 9906

Curves for 60 Hz are available on request.

SUBMERSIBLE PUMPS AFP 0831 to 2046

Performance Curves 50 Hz, DN 150

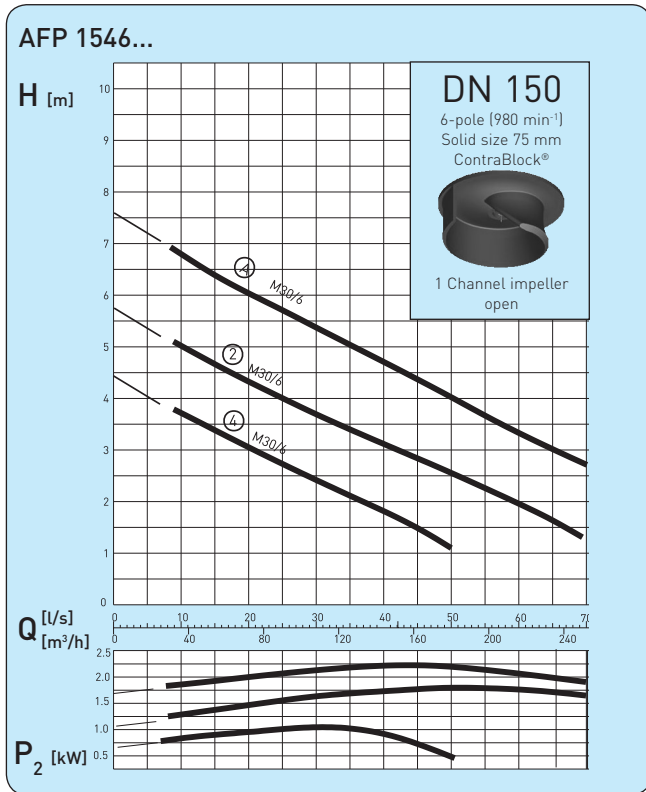

Performance Curves 50 Hz, DN 200

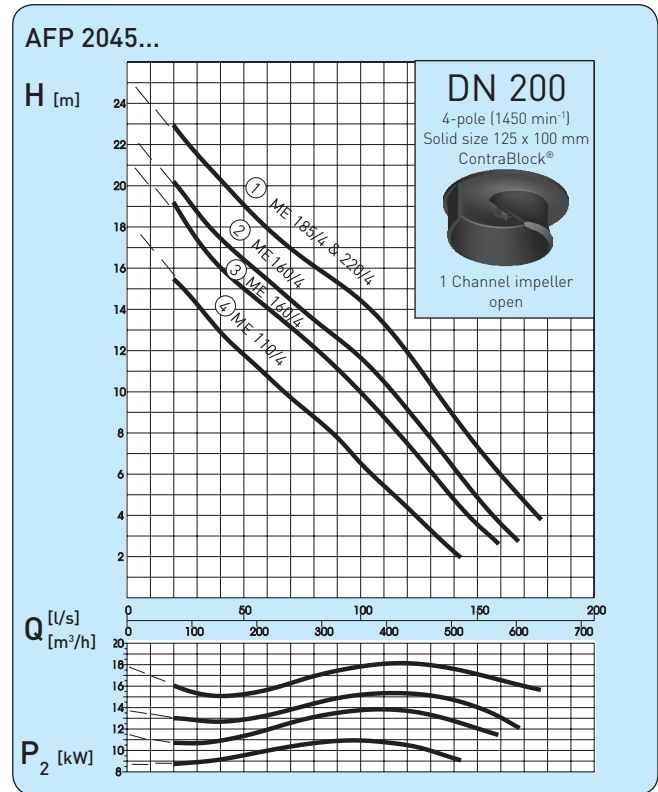

Performance Curves 50 Hz, DN 200

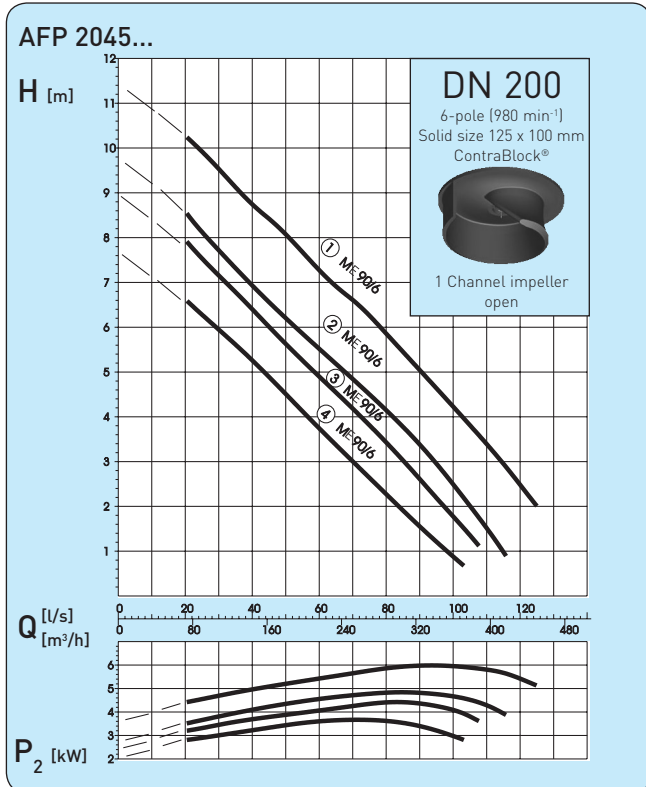

Performance Curves 50 Hz, DN 200

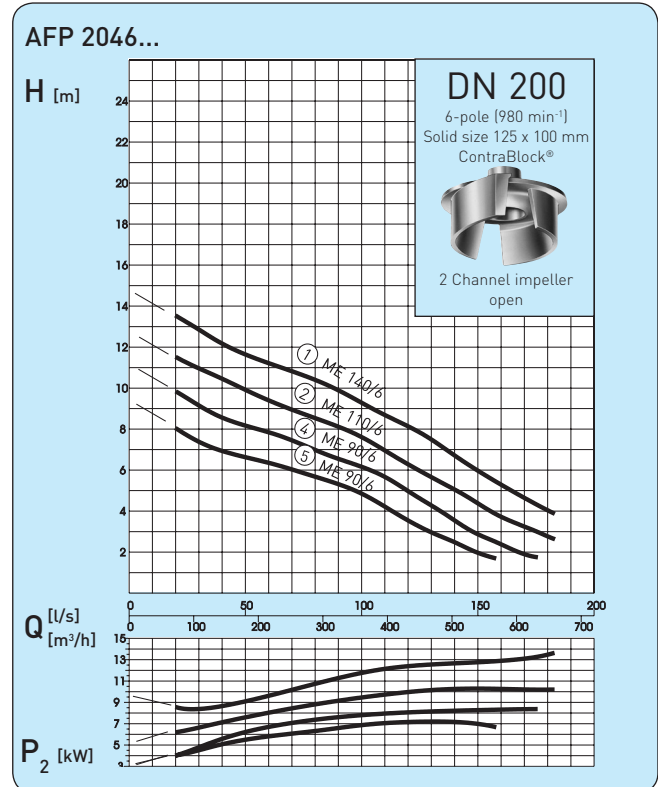

H = Total Head Q = Discharge Volume P₂ = Power at motor shaft

Curves to ISO 9906

Curves for 60 Hz are available on request.

Installation Dimensions with Pedestal and Cooling Jacket (example)

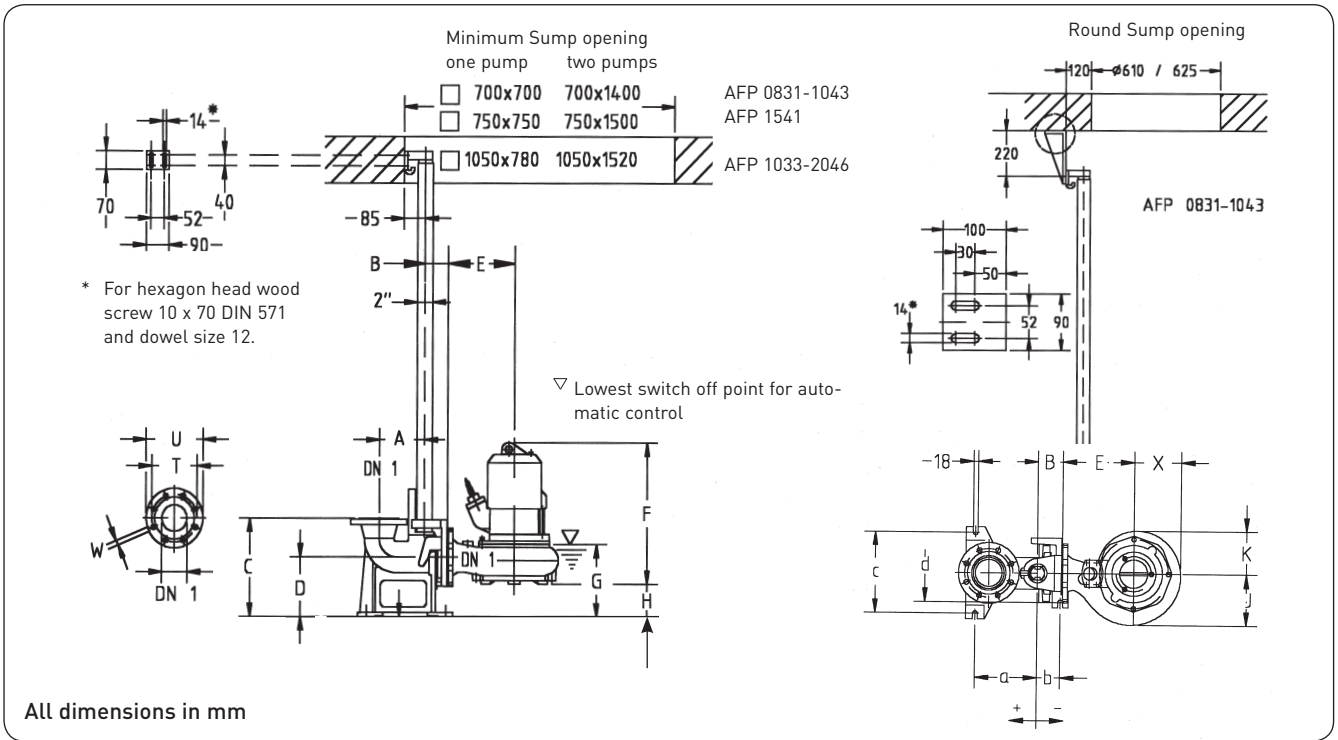

Dimensions for Dry Installation

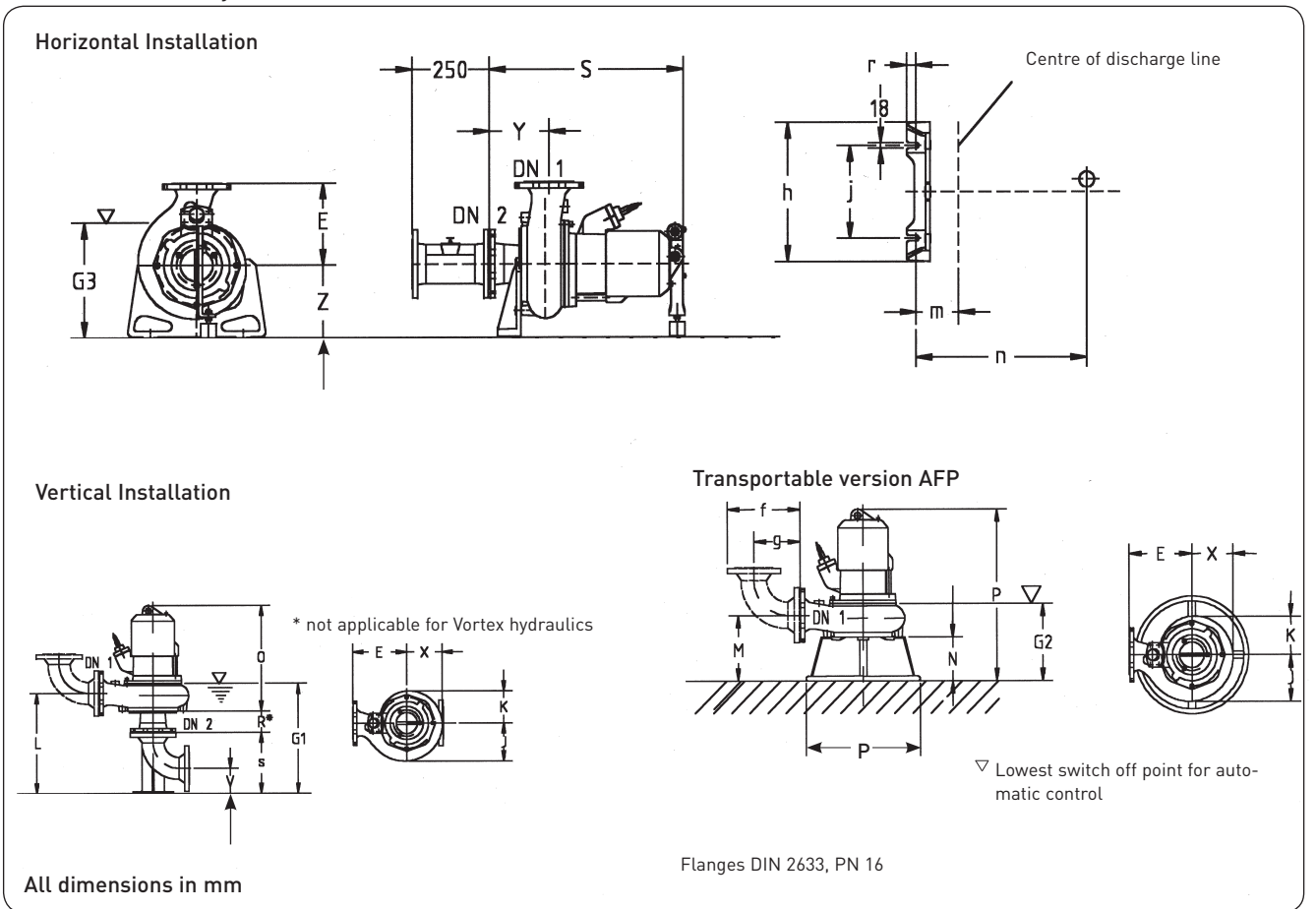

Hydraulics	R*	S	T	U	V	W	X	Y	Z	a	b	c	d	f	g	h	j	m	n	r	s
AFP 1541	138	766	240	285	125	22	215	244	235	272	-18	270	270	275	170	450	300	154	624	30	380
AFP 1541 M90/4	138	816	240	285	125	22	215	244	235	272	-18	270	270	275	170	450	300	154	668	30	380
AFP 1543	-	950	240	285	160	23	246	106	310	272	-18	270	270	430	260	520	370	140	780	30	380
AFP 1546	-	628	240	285	160	23	215	131	235	272	-18	270	270	362	220	450	300	154	630	30	380
AFP 1546 M90/4	-	676	240	285	160	23	215	131	235	272	-18	270	270	362	220	450	300	154	678	30	380
AFP 2045	-	1007	295	340	190	23	289	145	310	300	-130	420	340	498	300	520	370	160	819	30	450
AFP 2046	-	1007	295	340	190	23	289	145	310	300	-130	420	340	498	300	520	370	160	819	30	450

* Not applicable to Vortex hydraulics

Dimensions with S-Motor

AFP 0831

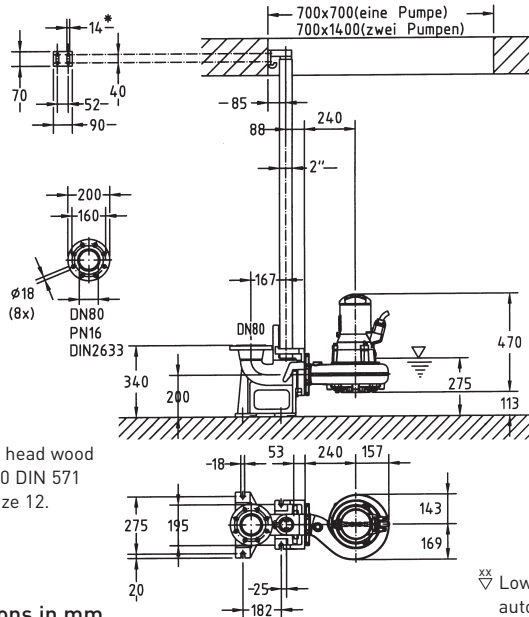

* For hexagon head wood screw 10 x 70 DIN 571 and dowel size 12.

All dimensions in mm

AFP 0841

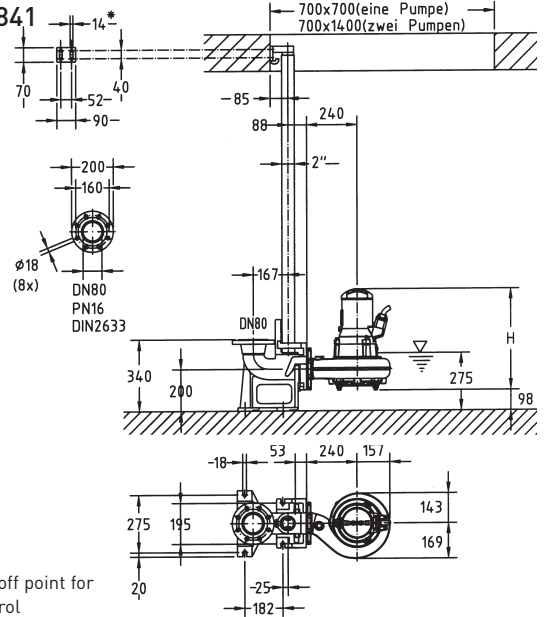

xx Lowest switch off point for automatic control

Accessories Installation with Pedestal

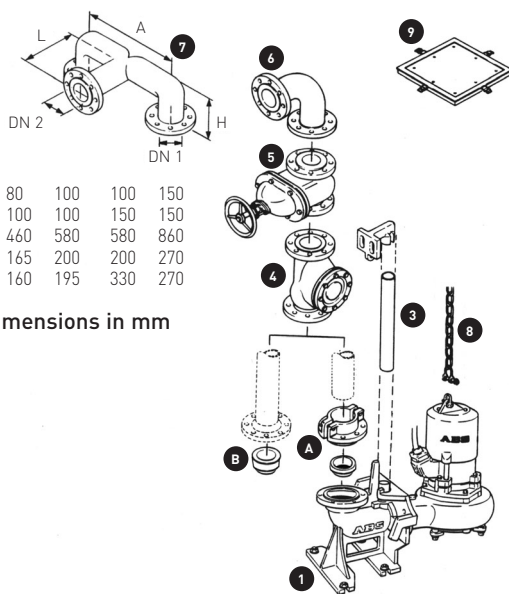

DN 1	80	100	100	150
DN 2	100	100	150	150
A	460	580	580	860
H	165	200	200	270
L	160	195	330	270

All dimensions in mm

Fixed Installation (wet) with ABS duckfoot pedestal

Description (Material)	Size	Part No.
1 Pedestal with cast on 90° Bend (GG-25 cast iron) for ABS Automatic Coupling System with:		

Description (Material)	Size	Part No.	
A Plug/clamp connection for discharge pipe	A- ϕ 90 mm A- ϕ 109 mm A- ϕ 115 mm A- ϕ 160 mm A- ϕ 169 mm	DN 80 DN 100 DN 100 DN 150 DN 150	6 232 0650 6 232 0653 6 232 0654 6 232 0656 6 232 0657
B with DIN-flange connection		DN 80 DN 100 DN 150 DN 200	6 232 0649 6 232 0652 6 232 0655 6 232 0658
3 Guide tube (steel, galv.)	2"	1 m 2 m 3 m 4 m 5 m 6 m	3 138 0001 3 138 0002 3 138 0003 3 138 0004 3 138 0005 3 138 0006
available at an additional cost: pipe connector with securing pins for guide tube length above 6 m			
4 Non-return valve (GG-20 cast iron) including 1 set of bolts and 1 gasket		DN 80 DN 100 DN 150 DN 200	6 140 0534 6 140 0535 6 140 0542 1 404 0064
5 Gate valve (GG-20 cast iron) including hand wheel, 1 set of bolts and 1 gasket, flanges to PN 16		DN 80 DN 100 DN 150 DN 200	6 142 0500 6 142 0501 6 142 0503 6 142 0504
7 Junction piece (St. 37 steel) to join the two discharge lines in the case of a twin-pump station		DN 80/100/80 DN 100/100/100 DN 100/150/100 DN 150/150/150	6 261 0025 6 261 0026 6 261 0005 6 261 0006
8 Chain (steel, galv.) including shackle		3 m 4 m 6 m 7 m	6 126 5065 6 126 5093 6 126 5069 6 126 5096
9 Sump cover (St. 37 steel) with frame and seal		700x 700 mm 700x1400 mm	1 499 0052 1 499 0053
6 90° Bend, Q-piece (SG iron to DIN 28637)		DN 80 DN 100 DN 150 DN 200	6 261 0302 6 261 0303 6 261 0305 6 261 0306

SUBMERSIBLE PUMPS AFP 0831 to 2046

Accessories

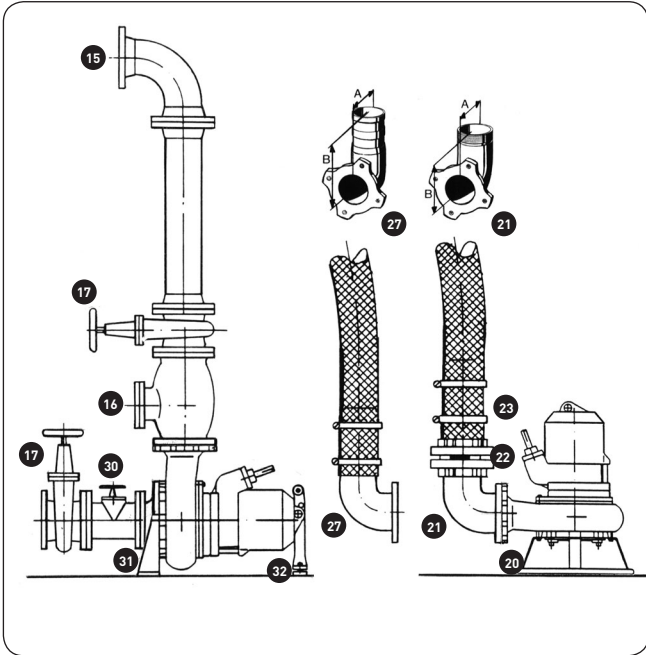

Description (Material)	Size	Part No.
Horizontal Dry Installation (HA version)		
15 90° Bend, Q-piece (SG iron to DIN 28637)	DN 80 DN 100 DN 150 DN 200	6 261 0302 6 261 0303 6 261 0305 6 261 0306
16 Non-return valve - Ball type (GG-20 cast iron) including 1 set of bolts and 1 gasket	DN 80 DN 100 DN 150 DN 200	6 140 0534 6 140 0535 6 140 0542 1 404 0064
30 Flanged intermediate piece (GG-20 cast iron) with inspection opening, including 1 set of bolts and 1 gasket	DN 100 L = 250	6 158 0001

Description (Material)	Size	Part No.
31 Volute support (GG-20 cast iron) with	AFP 0841 (M-Motor), 0842, 0844 AFP 0848, 1043, 1048	6 182 0025
32 Head support (GG-20) complete with fastening bolts, vibration damper and volute support	AFP 0831 (M-Motor), 0832, 0834, AFP 1031, 1041 AFP 1032, 1034, 1042 AFP 1049, 1541 AFP 1033, 1045, 1533 AFP 1543, 2045, 2046 AFP 0831, 0841 (S-Motor)	6 182 0040 6 182 0041 6 182 5002 6 182 5001

Use with Ground Support Ring (Transportable version)

20 Ground support ring (St. 37 steel) for transportable applications with 1 set of bolts (steel, galv.)	Height	Outer dia.	
	AFP 0831 (S-Motor), 0841, 0842, 1043..CB	180 mm	
AFP 1041, 1042, 1541...CB	180 mm	480 mm	6 135 0527
AFP 0831 (M-Motor), 0832, 1031, 1032..V	110 mm	348 mm	6 135 0525
AFP 1033, 1045	204 mm	584 mm	6 135 5004
AFP 1049, 1062, 1562	218 mm	605 mm	6 135 5005
AFP 1533, 1543	228 mm	682 mm	6 135 5006
AFP 2045, 2046	254 mm	682 mm	6 135 5007
AFP 1034	110 mm	348 mm	6 135 5009
AFP 0844, 1048	218 mm	550 mm	6 135 5010

21 Discharge elbow with external thread for DIN-threaded-flange or fixed coupling	DN			
	A	B		
80	170	145	DN 80/G3" ø 88 mm	3 143 0509
100	190	160	DN 100/G4" ø 113 mm	3 143 0511
150	252	200	DN 150/G6" ø 164 mm	3 143 0510

22 Fixed coupling (Aluminium) with internal thread	STORZ	B/G		
		3"	4"	
		F/G 6"		1 500 0024 1 500 0022 1 500 0027

23 Hose coupling (Aluminium) with long nozzle	STORZ	Gr. B		
		3"/DN 75	4"/DN 100	
		Gr. F 6"/DN 150		1 500 0006 1 500 0017 1 500 0016

27 Discharge elbow with hose nozzle (GG-20)	DN			
	A	B		
80	170	175	DN 80 (A-ø = 88 mm)	2 143 0512
100	190	215	DN 100 (A-ø = 108 mm)	2 143 0513
150	255	245	DN 150 (A-ø = 158 mm)	2 143 0514

17 Gate valve (GG-20 cast iron) including hand wheel, 1 set of bolts and 1 gasket, flanges to PN 16	DN			
	80	100		
	DN 100	DN 150		6 142 0500 6 142 0501 6 142 0503
	DN 150	DN 200		6 142 0504

