

CTI Transfer Panel

OPERATORS INSTRUCTION MANUAL

GENERAL SAFETY INSTRUCTION

- > This system must always be installed and commissioned by competent and qualified personnel.
- > The maintenance operations must be carried out exclusively by authorised and appropriately trained personnel.
- > For more information see the Technical Instruction Manual.

GENERAL INTRODUCTION

NEW CTI enclosure integrates a new 4-pole change-over switch including electronics' control to meet standard IEC 60947-6-1. CTI enclosure is also available to standard IEC 61439-2.



SWITCH MODULE INTERFACE

The new enclosure design allows switch module front panel direct access without opening of the enclosure for:

1. Visualization of the current changeover panel position.
2. Functioning mode selection (Cover closed = Automatic / Cover open = Manual).
3. Handle for manual operation.
4. Handle insertion in manual mode only to guarantee the transfer operation in any situation.
5. Padlocking mechanism only in manual mode.

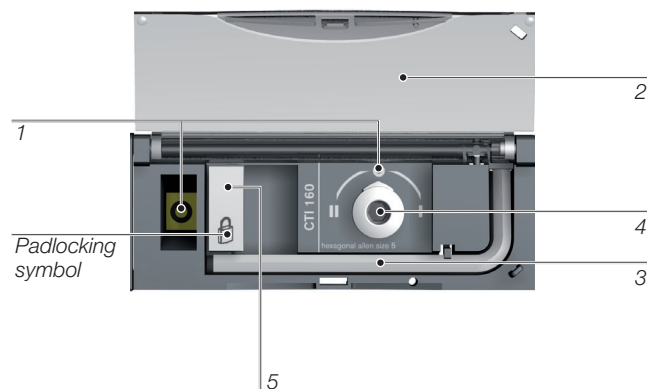

CTI Transfer Panel

OPERATORS INSTRUCTION MANUAL

ELETRONIC MODULE INTERFACE

The electronic module, also accessible from the front panel, includes:

1. Sources monitoring by Led (Availability, Positions I-0-II).
2. Transfer switches monitoring by Led (Functioning modes, Power supply, Fault).
3. Metering (Voltage (V) and Frequency (F) as standard), Sequences' timers & settings display.
4. Tests operations (On load & Off load).
5. Retransfer Inhibit (RTI) Led and push button.

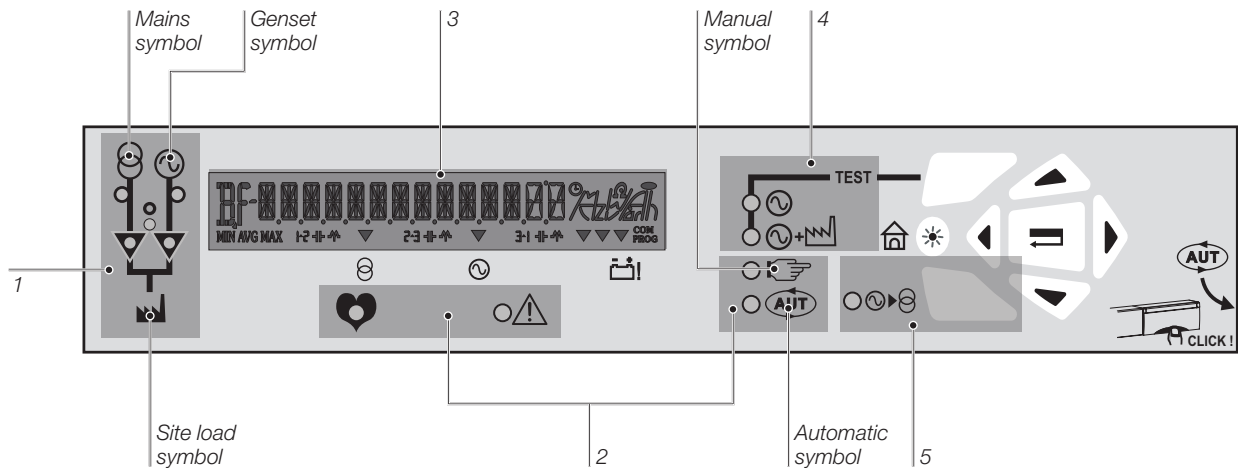

VISUALISATION

> Display

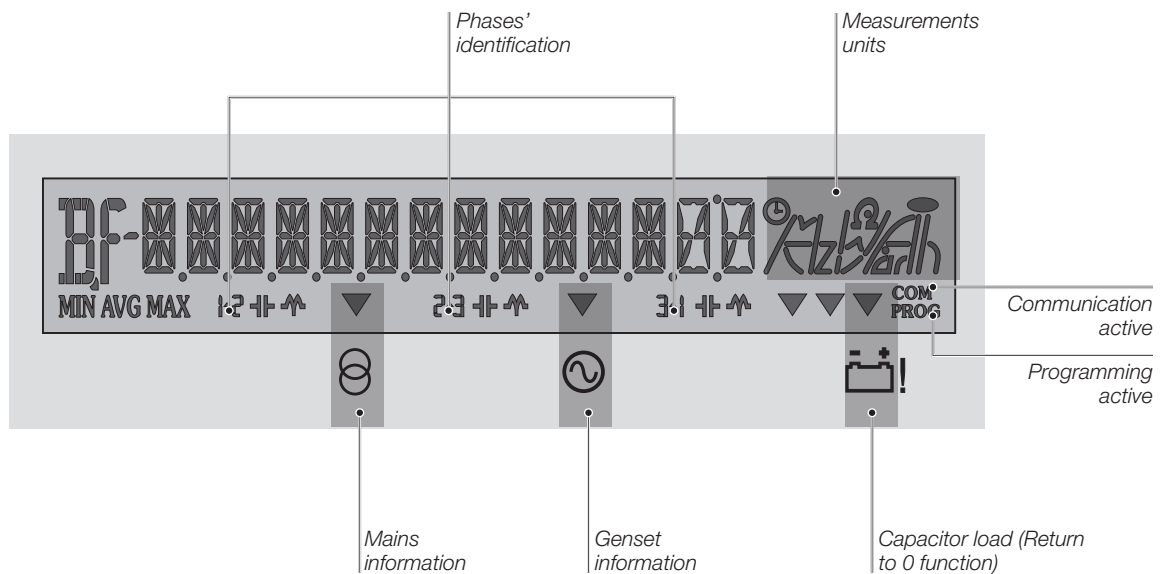





CTI Transfer Panel

OPERATORS INSTRUCTION MANUAL

VISUALISATION

> Led



• Sources availability

| Sources | Available | Not available |
|---------|---|--|
| Mains |  Led on |  Led off |
| Genset |  Led on |  Led off |

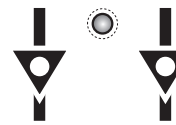
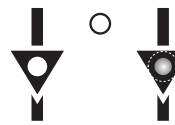
• Automatic Transfer Switch positions

| Position I Mains | Position 0 | Position II Genset |
|--|--|--|
|  Led on |  Led on |  Led on |

• Operating modes

| AUTO | MANUAL |
|---|---|
|  Led on |  Led on |



• Lamp test





> Timers

| Timer menu | | |
|--|--------------------------------|-----------|
| 1FT | Loss of mains validation timer | (3 sec) |
| Once mains has disappeared, 1FT is started. If Mains comes back before 1FT ends, the commutation cycle is not started. (Delay on Gen start.) | | |
| 2AT | Genset stabilisation timer | (5 sec) |
| Generator needs to be stable during 2AT to allow transfer from Mains. | | |
| 1RT | Mains Return validation timer | (180 sec) |
| Once Mains power has returned 1RT is started. If Mains power disappears before 1RT ends, the load is not switched back to the Mains. | | |



• Test modes

| On load | Off load |
|---|---|
|  Led on |  Led on |



• Retransfer inhibit function

| Active | Inactive | Blinking |
|---|---|-----------------------------------|
|  |  | Push the RTI button to retransfer |

• Power supply

| Active | Inactive | Blinking |
|--|--|------------|
|  Software Error |  Power supply off | Product OK |

• Fault synthesis

| Active | Inactive |
|--|---|
|  Product error |  Product OK |

| | | |
|--|-------------------|-----------|
| 2CT | Run on time timer | (180 sec) |
| Once the load is switched back from the Generator to the Mains, 2CT is started and the Generator will stop once 2CT is finished. (Allows generator cool down). | | |
| 0DT | Dead Band timer | (3 sec) |
| This timer is counted down before transferring the load from the Mains source to the Generator or vice versa. | | |

CTI Transfer Panel

OPERATORS INSTRUCTION MANUAL

OPERATING

> Automatic



In Auto Mode:

- Possible:
 - the automatic changeovers.
- Not possible:
 - to insert the handle
 - to pull the padlocking mechanism.

> Manual

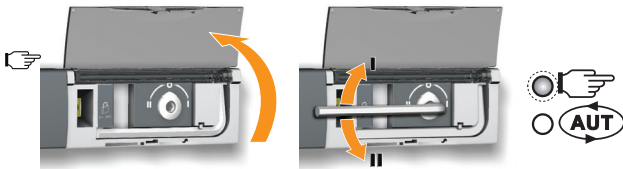

In Manual Mode:

- Possible:
 - to insert the handle and to operate manually.
- Not possible:
 - to operate electrically.

> Padlocking

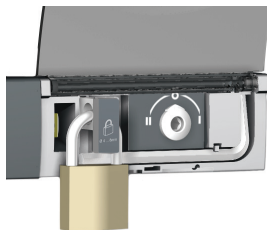

In Padlocking Mode:

- Possible:
 - to padlock in position 0 with a standard configuration.
- Not possible:
 - to operate electrically
 - to select the auto mode.

** Please note padlock is not supplied with panel.*

> Start/Stop group contact connection

Start Signal; Start & Stop (X & Y) should be connected to “control panel autostart signal”. Refer to control panel schematic for details.

CTI Transfer Panel

OPERATORS INSTRUCTION MANUAL

FAULT FINDING GUIDE

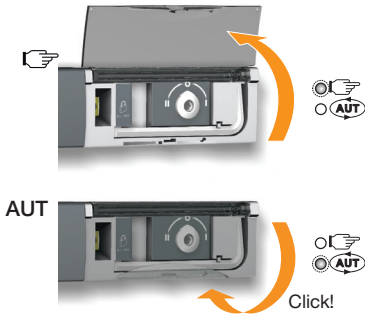
| Symptom | Step | Result |
|--|--------------------------------------|---|
| 01 Automatic operations availability. | 01 AUTO Led is on. | > NEGATIVE <ul style="list-style-type: none"> • Check that the switch has not been padlocked. • Check that the manual operating handle has been removed from housing. • Close the Auto/Manu front cover. • Then consult your local dealer. |
| | | > POSITIVE <ul style="list-style-type: none"> • Go to the next step. |
| | 02 Fault synthesis Led is off. | > NEGATIVE <ul style="list-style-type: none"> • Led is on Try to reset the product (see the instructions below). Then consult your local dealer. |
| | | • Reset  |
| | | > POSITIVE <ul style="list-style-type: none"> • Go to the next step. |
| | 03 Power supply Led is blinking. | 03 Power supply Led is blinking. |
| > POSITIVE <ul style="list-style-type: none"> • Go to the next symptoms. | | |
| 02 The mains availability. | 01 Mains availability Led is on. | > NEGATIVE <ul style="list-style-type: none"> • Check lamp test. • Check that the mains return timer (1RT) is still not counting down. • Check that the mains protection system (breaker) is on (Position 1). • Then consult your local dealer. |
| | | > POSITIVE <ul style="list-style-type: none"> • Go to the next steps or symptoms. |
| 03 The genset availability (genset supposed started). | 01 Genset availability Led is on. | > NEGATIVE <ul style="list-style-type: none"> • Check lamp test. • Check that the genset stabilisation timer (2AT) is still not counting down. • Check that the genset protection system (breaker) is on (Position 1). • Then consult your local dealer. |
| | | > POSITIVE <ul style="list-style-type: none"> • Go to the next steps or symptoms. |

CTI Transfer Panel

OPERATORS INSTRUCTION MANUAL

FAULT FINDING GUIDE

| Symptom | Step | Result |
|--|--|--|
| 04 The product doesn't transfer to the genset in case of mains failure or test on load. | 01 AUT Led is on & Fault synthesis Led is off & Power supply Led is blinking. | > NEGATIVE • Go to symptom 01. |
| | | > POSITIVE • Go to the next step. |
| | 02 Genset is started. | > NEGATIVE • Check that the mains failure timer (1FT) is still not counting down. • Check the genset control panel is set to the auto position. • Then consult your local dealer. |
| | | > POSITIVE • Go to the next step. |
| | 03 Genset availability Led is on. | > NEGATIVE • Go to symptom 03. |
| | | > POSITIVE • Consult your local dealer. |
| 05 The product doesn't transfer to the mains in case of mains return or test on load end. | 01 AUT Led is on & Fault synthesis Led is off & Power supply Led is blinking. | > NEGATIVE • Go to symptom 01. |
| | | > POSITIVE • Go to the next step. |
| | 02 Mains availability Led is on. | > NEGATIVE • Go to symptom 02. |
| | | > POSITIVE • Go to the next step. |
| | 03 Retransfer inhibit (RTI) function is off. | > NEGATIVE • Push the RTI push button:  |
| | | > POSITIVE • Consult your local dealer. |
| 06 Genset keeps on running after mains restores and switch retransfers to the mains position. | 01 AUT Led is on & Fault synthesis Led is off & Power supply Led is blinking. | > NEGATIVE • Go to symptom 01. |
| | | > POSITIVE • Go to the next step. |
| | 02 The run on time timer (2CT) is still counting down (visible on the display). | > NEGATIVE • Check the genset control panel is set to the auto position. • Then consult your local dealer. |
| | | > POSITIVE • Wait for the 2CT end. |

CTI Transfer Panel

OPERATORS INSTRUCTION MANUAL

FAULT FINDING GUIDE

| Symptom | Step | Result |
|--|---|--|
| 07 Switch manual operations are not possible. | 01 The manual operation is possible | > NEGATIVE • Check the required rotation of the switch • Check that the sufficient torque has been applied. • Then consult your local dealer. |
| | | > POSITIVE • Goal reached. |
| 08 Switch padlocking operations are not possible. | 01 Possible to pull the padlocking mechanism | > NEGATIVE • Check that the product is in the 0 position for standard configuration. • Then consult your local dealer. |
| | | > POSITIVE • Goal reached. |

CTI Transfer Panel

OPERATORS INSTRUCTION MANUAL

CONDITIONS OF USE



Hygrometry:

- 80% humidity without condensation at 55 °C
- 95 % humidity without condensation at 40 °C



Temperature:

- -10 +40 °C without de-rating
- +40 +65 °C with de-rating*



Ingress Protection:

- Enclosed: IP41
- Loose: IP2x



Storage:

- Temperature -20 to +40 °C
- Period: 1 year max



Power input:

- $V_n = 230\text{Vac}$ --> [160 / 305Vac]

* For de-rating information see Instruction Manual.

INSTRUCTION MANUAL REFERENCE

> For detailed instruction & installation guide, please refer to:

